

WÖHLER

Operating manual
Service Camera **EN**

Wöhler VIS 200 / 250
Wöhler VIS 300 / 350



Order no. 23164 2015-08-03

The measure of technology

Contents

1	General Information.....	5
1.1	Information about the operating instructions .	5
1.2	Notes.....	5
1.3	Proper use.....	6
1.4	Scope of supply.....	6
1.5	Transporting.....	7
1.6	Information on disposal.....	7
1.7	Manufacturer's address.....	7
2	Important information.....	8
3	Camera Models	10
4	Technical data	11
4.1	Monitor	11
4.2	Miniature Camera Head (Wöhler VIS 200/250).....	11
4.3	Miniature Camera Head (Wöhler VIS 300/350).....	12
4.4	Push rod.....	13
4.5	Electronic meter counter	13
4.6	Memory (Wöhler VIS 250 / 350).....	13
5	Design and function	14
5.1	Video inspection system.....	14
5.2	Control panel.....	16
5.3	Monitor Settings	19
5.4	Monitor Menu	19
5.5	Submenu „Picture“	20
5.5.1	Selecting the language.....	20
5.5.2	Setting the picture parameters in the monitor menu	20
5.6	Format.....	21
5.6.1	Turning the screen view	21
5.6.2	Changing the screen format	21
5.6.3	Selecting the video standard	21
5.7	Submenu „Option“ - Automatic shutdown....	22

6	Making settings via the camera menu..	23
6.1	Settings Wöhler VIS 250/350.....	23
6.1.1	SETUP-Menü.....	24
6.1.2	CALENDAR menu	26
6.1.3	VIDEO MENU	27
6.1.4	INFO menu	28
6.2	Making settings: Wöhler VIS 300.....	28
6.3	Selecting the unit: Wöhler VIS 200	29
7	Getting started	30
7.1	Rechargeable battery status and recharging	30
7.2	Working position	32
8	Working with the camera	32
8.1	Switching on the system and monitor	32
8.2	Inspection	34
8.3	Information displayed on the monitor	34
8.3.1	Displaying the position of the camera head (Wöhler VIS 250/350)	34
8.4	Memory Card Missing.....	35
8.5	Home Function (only Wöhler VIS 350)	35
8.6	Video Record (Wöhler VIS 250 / 350).....	36
8.7	Video playback (Wöhler VIS 250 / 350)	37
9	Images (Wöhler VIS 250 / 350).....	38
10	Delete a Video or an image (Wöhler VIS 250 / 350)	38
11	Transferring and showing images and videos (Wöhler VIS 250 /350)	39
11.1	Transferring to the PC	39
11.2	Replaying videos on the PC.....	39
12	Guide accessories.....	40
13	Faults	41
14	Maintenance	42
14.1	Regular maintenance.....	42

14.2	Changing the dome of the Camera Head Wöhler VIS 300/350	42
14.3	Camera head	42
14.4	Push rod.....	42
14.5	Monitor	42
15	Warranty and service	43
15.1	Warranty.....	43
15.2	Service	43
16	Accessories.....	44
17	Declaration of conformity EC	44
	Points of sale and service	45

1 General Information

1.1 Information about the operating instructions

Read these operating instructions carefully. They will enable you to operate the Wöhler VIS 200/250 and VIS 300/350 safely. Keep this manual for your information

This manual refers to different camera models. Therefore it may include instructions which do not apply to your camera. Those explanations which do not mention one or more camera models explicitly, refer to all four models.

The Wöhler VIS 200/250 and Wöhler VIS 300/350 should be used by trained professionals for its intended use only.

Liability is voided for any damages caused by not following this manual.

1.2 Notes



WARNING!

Not following this warning can cause injury or death.



ATTENTION!

Not following this note can cause permanent damage to the camera.



NOTE!

Useful information

1.3 Proper use

The Camera is designed to visually inspect and document the condition of pipes and shafts, for example in flue gas systems, ventilation systems as well as for inspecting underground pipes etc. The device is designed to be used by trained professionals only.

Any other use is considered improper use.

1.4 Scope of supply

Device	Scope of supply
Wöhler VIS 200 / 250 Wöhler VIS 300 / 350	Case
	Push rod
	Monitor
	1 anti-slide-mat
	NiMH battery
	mini USB cable (Wöhler VIS 250 / 350)
Wöhler VIS 200/250/300	1 rechargeable battery 12 V NiMH
Wöhler VIS 350	2 rechargeable batteries 12 V NiMH
Wöhler VIS 200 / 250	Miniature Camera Head Colour
Wöhler VIS 300 / 350	Pan & tilt colour camera head
	5 replacement plastic domes
Wöhler VIS 250 / 350	SD card 4 GB

1.5 Transporting

To avoid damage occurring during transport it is imperative that the instrument is transported in the original case designed for the purpose.

1.6 Information on disposal



Do not dispose of electronic equipment in domestic waste. Dispose of electronic equipment in accordance with applicable environmental regulations.

You may hand in any defective batteries taken out of the unit to our company as well as to recycling places of public disposal systems or to selling points of new batteries or storage batteries.



1.7 Manufacturer's address Wöhler Messgeräte Kehrgeräte GmbH

Schützenstr. 41
33181 Bad Wünnenberg
Tel.: +49 2953 73-100
Fax: +49 2953 73-96100
Email: mgkg@woehler.de

2 Important information

Eye protection



WARNING!

Never point a connected camera head at your own or somebody else's eyes when the camera is switched on. The LEDs are extremely bright and can cause eye damage.



WARNING!

Guide the rod with due care and attention. As the rod is made of flexible material, it can make whipping movements if it slips. Protect your eyes in particular.

Working environment



WARNING!

Only place the camera on firm level ground and ensure a secure position of camera and user, especially when working in high altitude, e.g. when working on the roof.



WARNING!

Make sure that the parts that you are going to inspect are no live parts.



CAUTION!

Protect the camera head against oil and acid. Never use the camera head and rod to push obstructions.

Operating temperature



CAUTION!

Do not use the camera in temperatures above 40°C. High temperatures can damage the camera.

Resistance to water



CAUTION!

Only the camera head and the rod are waterproof. Keep the camera system dry and away from water!

Resistance to impacts



CAUTION!

The camera system is not impact resistant. Do not throw or allow the case to fall!

Accessories



CAUTION!

Use only original Wöhler accessories and spare parts!

Strong magnetic or electric fields



NOTE!

Do not use the camera near television towers, mobile radio equipment or other sources of magnetic or electric fields, as these may impair the quality of the displayed image.

Extraneous influences



NOTE!

Extraneous influences such as static discharges can cause the device to malfunction. If a malfunction occurs, switch the monitor off and on again.

3 Camera Models

Different camera models Wöhler VIS can be acquired. The difference between the models described in this version are as follows:

	VIS 350	VIS 300	VIS 250	VIS 200
Camera head	Ø 40 mm pan & tilt	Ø 40 mm pan & tilt	Ø 26 mm	Ø 26 mm
integrated transmitter	✓ ¹	✓ ²	✓ ¹	✓ ²
Position indicator	✓		✓	
Electronic meter counter	✓	✓	✓	✓
Record video	✓		✓	
Menu	✓		✓	
Home function	✓			
Control panel	7 keys with shift	5 keys	7 keys	1 key
Application	<ul style="list-style-type: none"> • Flue gas lines Ø 60 mm and larger with 87° bends (and smaller) • Waste water lines of Ø 70 mm and larger • Chimneys • Ventilation lines of Ø 60 mm and larger • Analyse damage in Waste water pipes of Ø 70 mm and larger 		<ul style="list-style-type: none"> • Flue gas lines 40 mm and larger • Ventilation lines of Ø 40 mm and larger • Analyse damage in Waste water pipes of Ø 40 mm up to Ø 125 mm 	

¹ The transmitter can be switched on and off in the menu, see chapter **Fehler! Verweisquelle konnte nicht gefunden werden.**

² When the camera is switched on, the transmitter will be permanently active.

4 Technical data

4.1 Monitor



Fig. 1: Monitor

Description	Details
TFT display	7" / 16:9 and 4:3 format (Default 16:9)
Weight	400 g
Dimensions housing	176 x 114 x 32 mm
Video output	FBAS signal
Power supply	via camera system
Voltage	12 V
Operating temperature	0-40 °C
Storage temperature	-20 °C – 50 °C
Connection cable to the camera system	2 m

4.2 Miniature Camera Head (Wöhler VIS 200/250)



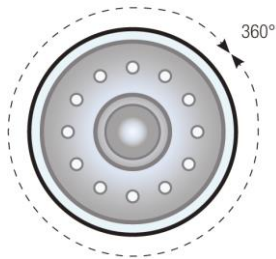
Fig. 2: Miniature Camera Head

Description	Details
Type:	1/3" COLOR CMOS
Lens:	f = 2.3 mm, F = 2.5
Viewing angle:	120°
Light source:	12 white LEDs
Degree of protection:	Waterproof to IP 68
Dimensions	Ø 26 mm x 38 mm
Frequency of the transmitter integrated in the camera head	8.9 kHz

4.3 Miniature Camera Head (Wöhler VIS 300/350)

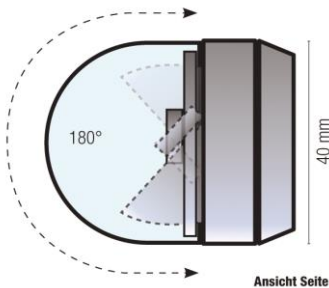


Fig. 3: Camera Head pan & tilt



Ansicht Front

Fig. 4: Pan the camera head 360°



Ansicht Seite

Fig. 5: Tilt the camera head 180°

Description	Details
Type:	1/3" COLOR CMOS
Lens:	f = 2.3 mm, F = 2.5
Viewing angle:	120°
Light source:	12 white LEDs
Degree of protection:	Waterproof to IP 67
Dimensions	Ø 40 mm x 60 mm
Frequency of the transmitter integrated in the camera head	8.9 kHz

4.4 Push rod

Description	Details
Length:	20 m optional 30 m
Diameter	6.5 mm (VIS 3xx) 6 mm (VIS 2xx)

4.5 Electronic meter counter

Description	Details
Resolution:	0.04 m
Maximum Deviation	5 % of reading

4.6 Memory (Wöhler VIS 250 / 350)

Description	Details
Memory card	32 GB max. (If you are using a memory card other than the one included in the scope of supply, you must format it first (FAT32) before you can use it on a PC.)
Capacity	ca. 1h / GB
Resolution of the video	640 x 480 (VGA)/ max. 30 fps
Video format	ASF (MPEG4)

5 Design and function

5.1 Video inspection system

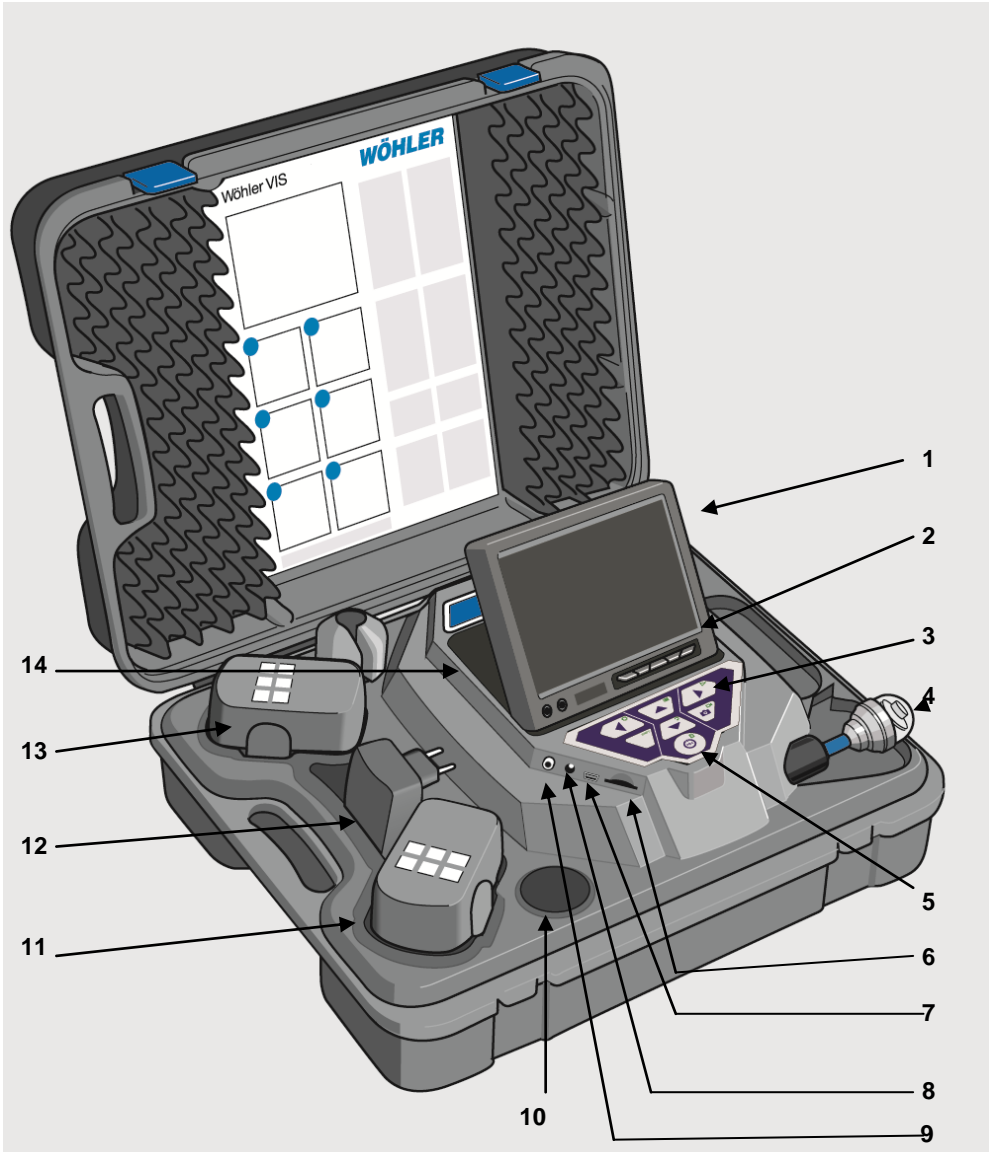


Fig. 6: Case (Wöhler VIS 350)

Legend

- 1** Monitor
- 2** Monitor controls
 - Brightness / contrast
 - Colour
- 3** Camera control
 - with record and play - function (Wöhler VIS 250 / VIS 350)
 - home function aligns the camera head to a straight position and menu for the monitor settings (Wöhler VIS 350)
- 4** camera head, waterproof:
 - Wöhler VIS 300 / VIS 350: pan and tilt colour camera head 40 mm Ø
 - Wöhler VIS 200 / 250 Miniature colour camera head Ø 26 mm
- 5** Main power switch with the following functions:
 - ON /OFF (system)
 - Reset distance measurement
 - Escape
 - Delete (when SHIFT mode is activate)
- 6** Cardslot for memory card (Wöhler VIS 250 / 350)
- 7** Mini-USB-port (Wöhler VIS 250 / 350)
- 8** Power supply socket (18V/1,6A)
- 9** Video out
- 10** Accessory compartment 1
- 11** Rechargeable battery, extra (only Wöhler VIS 350)
- 12** Power supply
- 13** Rechargeable battery, in use
- 14** Accessory compartment 2

5.2 Control panel

VIS 200

Control Panel Wöhler VIS 200 with ON/OFF-key



Fig. 7: Control Panel
Wöhler VIS 200

VIS 300

Control Panel Wöhler VIS 300 with ON/OFF-key
and control keys for the pan and tilt camera head



Fig. 8: Control Panel
Wöhler VIS 300

Wöhler VIS 250 / 350

Control Panel
Wöhler VIS 250 / 350

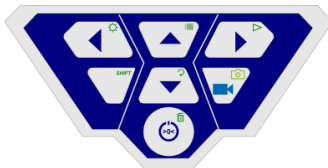



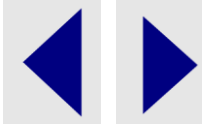













Fig. 9: Control Panel
Wöhler VIS 250 / 350

The keys on the control panel have the following functions:

	<p>Wöhler VIS 200/250/300/350</p> <p>ON/OFF key turns the whole camera system on/off (monitor and camera head).</p> <p> NOTE! <i>The ON/OFF key is framed by a green light when the system is switched on and the battery is charged.</i> <i>The lower half of the light framing the ON/OFF key flashes red during the recharging process.</i></p>											
<p>Functions The ON/OFF key</p>	<table border="1"> <thead> <tr> <th data-bbox="432 577 703 627">Press</th> <th data-bbox="703 577 978 627">Function</th> </tr> </thead> <tbody> <tr> <td data-bbox="432 627 703 743">When the system is switched off: Briefly</td> <td data-bbox="703 627 978 743">Switch system on</td> </tr> <tr> <td data-bbox="432 743 703 860">When the system is switched on: Hold 2 seconds</td> <td data-bbox="703 743 978 860">Switch system off</td> </tr> <tr> <td data-bbox="432 860 703 976">When the system is switched on: Briefly</td> <td data-bbox="703 860 978 976">Reset distance counter</td> </tr> <tr> <td data-bbox="432 976 703 1118">When the system is switched on: (Wöhler VIS 250 / 350)</td> <td data-bbox="703 976 978 1118">Escape Exit menu</td> </tr> </tbody> </table>		Press	Function	When the system is switched off: Briefly	Switch system on	When the system is switched on: Hold 2 seconds	Switch system off	When the system is switched on: Briefly	Reset distance counter	When the system is switched on: (Wöhler VIS 250 / 350)	Escape Exit menu
Press	Function											
When the system is switched off: Briefly	Switch system on											
When the system is switched on: Hold 2 seconds	Switch system off											
When the system is switched on: Briefly	Reset distance counter											
When the system is switched on: (Wöhler VIS 250 / 350)	Escape Exit menu											
	<p>Camera head operating keys (Wöhler VIS 300/350)</p> <p>Tilt the camera head 180°</p>											
	<p>Camera head operating keys (Wöhler VIS 300/350)</p> <p>Rotate the camera head 360°</p>											

Wöhler VIS 250 / 350	
	<p>VIDEO key Start/stop recording video</p>
	<p>SHIFT key Activates the key functions depicted by green icons on the top right corners of the keys.</p> <div style="background-color: #f0f0f0; padding: 5px; border: 1px solid #ccc;"> <p> NOTE! When SHIFT MODE is activate, the SHIFT key lights up and an S is displayed in the bottom middle of the screen.</p> </div>
	<p>Illumination key Dimming function to set the brightness of the camera head lighting.</p> <div style="background-color: #f0f0f0; padding: 5px; border: 1px solid #ccc;"> <p> NOTE! There are three levels of brightness available to increase or dim the intensity of the camera head lighting. The brightness is increased each time the user presses the ILLUMINATION key three times in sequence. The fourth time the user presses the key, the lighting returns to the lowest level of brightness.</p> </div>
	<p>MENU key: Make settings</p>
	<p>PLAY key Playback recorded videos</p>
	<p>HOME key (only Wöhler VIS 350, Wöhler VIS 250: without function): Aligns the camera head to a straight position – displays view parallel to the ground above</p>

	<p>IMAGE key</p> <p>Capture image / snapshot</p> <p> NOTE! <i>Images are saved in .jpg format. It is possible to display the images on a PC from the SD card.</i></p>
	<p>DELETE key</p> <p>Delete an image or video selected in PLAY mode.</p>

5.3 Monitor Settings

It is possible to make setting via the monitor.

5.4 Monitor Menu

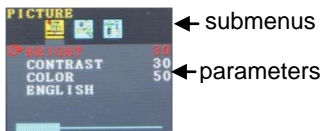
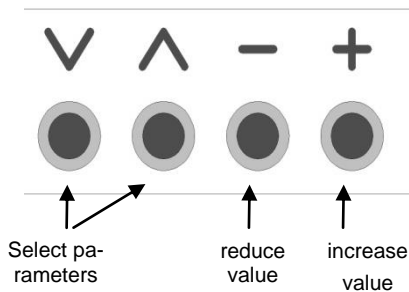


Fig. 10: Picture menu

- Press the menu key, to enter the monitor menu.

In the upper line, different icons will show 3 different submenus: Picture, Format, Option, Off

- Press M, to change between the submenus.
- Press „^“ or „v“, to switch between the parameters.
- Press „-“, to reduce a value.
- Press „+“, to increase a value.

5.5 Submenu „Picture“

5.5.1 Selecting the language

Nine different languages can be selected for the monitor menu: english, german, french, spanish, portuguese, italian, dutch, russian and Chinese.

- Press the menu key to select the first icon (Picture).
- Press **V** until you have reached the last parameter.
- Press **+** to select the language

5.5.2 Setting the picture parameters in the monitor menu



Fig. 11: Default settings

In the picture menu, the brightness, the contrast and the color can be adjusted from 0 to 100



NOTE!

The default settings are:

Bright: 30

Contrast: 30

Color: 50

A bar below the parameters shows the adjustment level.



NOTE!

When the camera head $\varnothing 26$ mm or $\varnothing 40$ mm is connected, the video quality can also be adjusted in the camera menu, see chapter 6.

5.6 Format

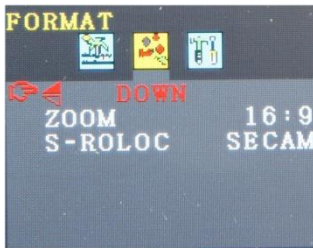


Fig. 12: Submenu Format

In the Format Menu the user can turn round the screen, the screen format can be changed from 16:9 to 4:3 and the video format can be selected.

- Press the menu key to select the second icon (Format).

5.6.1 Turning the screen view

CAUTION!

We recommend not to turn the screen view.

- Press **V** to select the first parameter (down).
- „Down“ shows the normal view.

If absolutely necessary, turn the screen by pressing the + or -: normal (turns 180°), down reflected and normal reflected.

5.6.2 Changing the screen format

- In the format menu press **V** to select the zoom parameter.
- Press **+** or **-** to change between 16:9 and 4:3 or FIT.

NOTE!

If you select 16:9 or 4:3 there will be frames on the screen. If you choose FIT the video will perfectly fit to the screen.

5.6.3 Selecting the video standard

In the submenu „S-Roloc the video standards PAL > NTSC > SECAM > AUTO can be selected. This setting only affects the screen. The default setting is „Auto“.

CAUTION!

We urgently recommend not to change the default setting „AUTO“.

5.7 Submenu „Option“ - Automatic shutdown



Fig. 13: automatic shutdown deactivated

In the submenu „Option“ the user has the possibility to activate an auto off-function for the monitor menu:

- Press the menu key to select the third icon (Option).
- Press + or – to select the time after which the monitor menu shall turn off automatically: 5 s > 10 s > off.



Note!

“OFF” is the default setting, so that the automatic shutdown will be deactivated.

6 Making settings via the camera menu

6.1 Settings Wöhler VIS 250/350

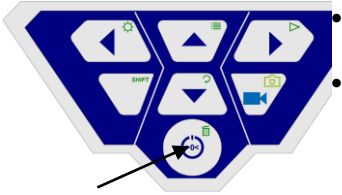


Fig. 14: ON/OFF key

- Switch on the camera system: briefly press the ON/OFF key at the bottom of the control panel.
- When the device is switched on, the light framing the ON/OFF key lights up green. The video image is displayed on the monitor after about 5 seconds.

- Press the SHIFT key.

The green light framing the SHIFT key lights up and an **S** is displayed in the middle at the bottom of the monitor. This indicates that SHIFT mode is active and the second functions marked in green on the keys are enabled.

- Press the Menu key 

The menu opposite is displayed on the screen with 5 sub-menus.

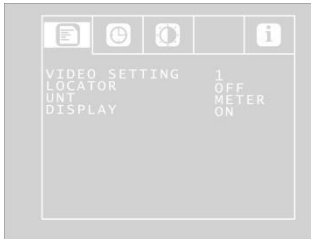


Fig. 15: SETUP menu
Wöhler VIS 250 / 350

Icon	Menu
	SETUP menu
	CALENDAR menu
	VIDEO menu (If you work with the camera head Ø 51 mm, there will be no video menu)
	INFO menu

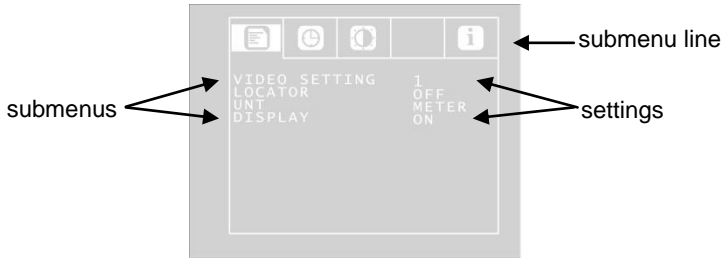


Fig. 16: SETUP menu

Navigating to the submenu

- Using the up/down arrows, navigate to the submenu line. Using the left/right arrow keys navigate to the submenu.

Navigating to the parameters

- Using the up/down arrows, navigate to the corresponding parameter. Select the desired setting using the left/right arrow keys.
- Press the ON/OFF key to confirm your selection and exit the menu.
- If there is no disc icon to save the settings, your settings will be saved automatically when you exit the menu.

The user can select the following parameter settings:

6.1.1 SETUP-Menü



Video Setting 1 – 3

(only if using the camera head Ø 40 mm and 26 mm)

The user can switch between 3 pre-defined video settings. The video settings 1 and 2 cannot be altered.

Video	Recommended
Video Setting 1	Recommended for pipes, good long field of vision
Video Setting 2	Recommended for chimneys; dark areas are made to appear brighter
Video Setting 3	User-definable settings

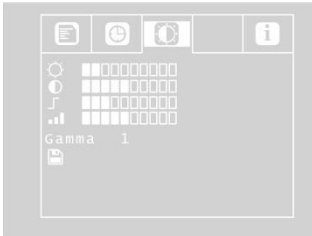


Fig. 17: User-definable Video setting 3

To define Video Setting 3, proceed as follows:

- In the menu view, use the up arrow key to navigate to the submenu line and then use the right arrow key to select the VIDEO tab. Adjust the settings as described in section 6.1.3
- Adjust the following settings as required:
 - ☀ Brightness
 - Contrast
 - ┌ : Contour sharpness
 - Colour saturation
 - Gamma: Gamma curve setting (0-3)



NOTE!

Adjustments to the gamma curve affects brightness curve settings.

- To save your settings, use the down arrow key to select the disc symbol below the parameter. Press the right or left arrow key.

This saves the settings for Video 3. For some seconds a hook will appear instead of the disc icon.

- Return to the SETUP menu view using the arrow keys.

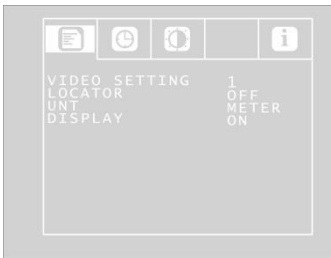


Fig. 18: SETUP Menu

LOCATOR OFF/ON

(only with camera heads Ø 26 and 40 mm)

This command allows the user to switch the transmitter integrated in the camera head on and off. The Wöhler L 200 Locator is able to locate the camera head with the aid of signals transmitted by the transmitter.

(only Ø 40 mm and Ø 26 mm camera heads are equipped with an integrated transmitter).

ON: Transmitter is switched on

OFF: Transmitter is switched off



NOTE!

The camera consumes less power when the transmitter is switched off. However, it is not possible to locate the camera head when the transmitter is switched off.

UNIT METER/FEET

Select Meter or Feet.

DISPLAY ON/OFF

This command allows the user to switch the on-screen display On or Off. Select "ON" if you wish to display the battery status indicator and the date on-screen.

6.1.2 CALENDAR menu

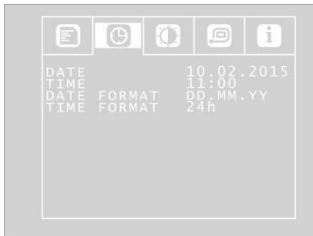


Fig. 19: Settings in the SETUP menu

Use the arrow keys to navigate to the CALENDAR menu. The following settings are available here:

DATE

Set the date.



NOTE

The date will be recorded together with the video.

TIME

Set the time. The time will be recorded together with the video.

DATE FORMAT

Set the date format to either Day.Month.Year or Month/Day/Year

TIME FORMAT 12h/24h

Set the time format to either 12 hour format or 24 hour format.

Exit menu

6.1.3 VIDEO MENU

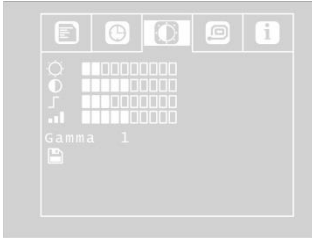


Fig. 20: VIDEO menu

To exit the menu, press the ON/OFF key.

The VIDEO menu will only be active, if the camera heads Ø 40 mm and 26 mm are used.

In the video menu the user can define the video settings. These settings will be stored as video settings 3. If the user changes anything in the video menu, automatically video settings 3 will be active (see SETUP menu)

- Adjust the following settings as required:
 - ☀ Brightness
 - Contrast
 - ┌┐ Contour sharpness
 - ▒▒▒ Colour saturation
 - Gamma: Gamma curve setting (0-3)



NOTE!

Adjustments to the gamma curve affects brightness curve settings.

- To save your settings, use the down arrow key to select the disc symbol below the parameter. Press the right or left arrow key.
- This saves the VIDEO SETTINGS 3. After that a hook will appear for some seconds instead of the disc icon.

6.1.4 INFO menu

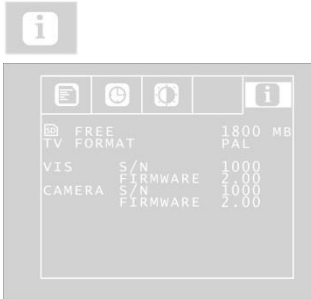


Fig. 21: INFO menu

The INFO menu shows important information about your camera system. It is not possible to make any settings in this menu.

FREE: Information about the free storage space on the memory card.

TV FORMAT: TV format of the camera head (PAL or NTSC)

VIS S/N: Serial number of the camera system

VIS FIRMWARE: Firmware version of the camera system

Camera S/N: Serial number of the camera head

CAMERA FIRMWARE: Firmware version of the camera head

6.2 Making settings: Wöhler VIS 300

- When the camera is switched on, keep the up arrow pressed for a second, until the camera menu appears.

The menu will appear on screen with 2 submenus:

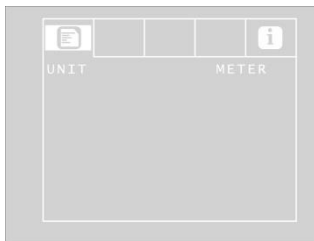


Abb. 22: Camera menu Wöhler VIS 300

Icon	Menu
	SETUP-menu to select the unit
	INFO-menu

Navigate in the menu as described in section 6

Select the distance unit which will be indicated in the display. This distance shows how many meters/feet of the rod are already pulled out of the case.

UNIT METER/FEET

6.3 Selecting the unit: Wöhler VIS 200

The Wöhler VIS 200 does not have any menu.

Nevertheless you can select the unit METER or FEET. The distance indicated at the lower left of the screen shows how many meters/feet of the rod are already pulled out of the case.

- When the camera is switched on, press 3 x the ON/OFF key shortly, to change the unit.

7 Getting started

7.1 Rechargeable battery status and recharging



WARNING!

Risk of injury when handling the rechargeable batteries improperly!

Never open the rechargeable battery housing.

Do not throw rechargeable batteries into a fire or expose to high temperatures. There is a risk of explosion!

If handled improperly, a liquid may emerge from rechargeable batteries that can cause skin irritation. Avoid contact with the liquid. Rinse skin with large amounts of water if it comes into contact with the liquid. If the liquid comes into contact with eyes, rinse with water immediately for 10 minutes and consult a doctor immediately!



WARNING!

Danger of death by electrocution!

Never touch an electrical outlet with wet hands!

Do not expose the power pack to moisture!

Never pull the cable to remove the power pack from the electrical outlet - it could rip out the cable!

Operate the power pack only when the mains power supply is the same as the voltage stated on the rating plate!



ACHTUNG!

Switch off the camera system before charging the battery.

Rechargeable battery status indicator

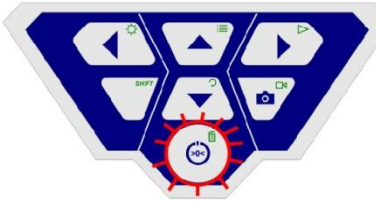


Fig. 23: Control panel of Wöhler VIS 250 / 350 - ON/OFF key framed by flashing light

When the camera is switched on, the battery status indicator displays the charge status of the rechargeable battery in the top right corner of the display. The indicator flashes when the charge level of the batteries is low. If the charge level continues to fall, the light framing the ON/OFF key flashes red and the camera switches off automatically.

It is only possible to switch on the camera again after the battery has been replaced with a charged battery or a power cable is connected to recharge the battery in use.

Charging rechargeable batteries

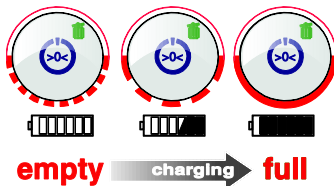


Fig. 24: Schematic overview of battery recharging

To recharge the battery, proceed as follows:

- Connect the power pack to the charger connection of the device and the main power supply.

The lower half of the light framing the ON/OFF key flashes red during the recharging process; when the battery is fully recharged it lights up red continuously as long as the power pack remains connected.



NOTE!

The operating time of the rechargeable battery is approx. 120 minutes.

7.2 Working position



Fig. 25: possible working position



WARNING!

Only place the camera on firm level ground and ensure a secure position of camera and user, especially when working in high altitude, e.g. when working on the roof. Because of its weight the case can cause considerable harm to persons and objects when falling down.

- Place the case so that the arrows on the blue clips show upwards.
- Pull the clips and open the case
- Place the monitor in the desired working position.



NOTE!

It is possible to pull the monitor out off the support and place it outside the case if your working position requires this. The connection cable to the case is 2 m long.

8 Working with the camera

8.1 Switching on the system and monitor

Wöhler VIS 250 / 350

- Insert a memory card (max. 32 GB).



NOTE!

If you are using a memory card other than the one included in the scope of supply, you must format it first (FAT32) before you can use it on a PC.

To format the card, proceed as follows:

- Insert the card into the card slot of your PC.
- In the Explorer, right-click the removable media memory card, then select "Format".
- Select FAT32 (default) and 32 kilobytes.

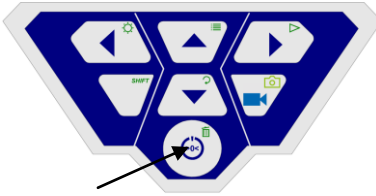


Fig. 26: ON/OFF key

- To switch on the device, briefly press the ON/OFF key at the bottom of the control panel.
- When the device is switched on, the light framing the ON/OFF key lights up green. The video image is displayed on the monitor after about 5 seconds.

8.2 Inspection

- Pull the rod smoothly out of the case and push the camera head to the area to be inspected.

! CAUTION!

*Do not exceed rod end limit!
Do not bend or drag across sharp edges!*

! CAUTION!

Dry and clean the rod with a cloth before pulling it back, so that no dirt and soot can enter!

8.3 Information displayed on the monitor

8.3.1 Displaying the position of the camera head (Wöhler VIS 250/350)

Pointer symbol

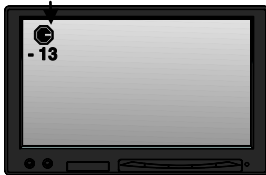


Fig. 27: Display with pointer symbol and number of degrees

A **pointer symbol** displayed in the top left corner of the screen always indicates the direction of gravity, meaning, towards the bottom. This ensures the user is able to recognize where top and bottom are in the pipe.

A circle is displayed around the symbol if the camera head faces vertically upwards.

A cross is displayed in the middle of the symbol if the camera head faces vertically downwards.

Number of degrees

The number of degrees displayed underneath indicates the downward gradient of the pipe.

Example graphic: - 13° corresponds to a downward grade of 13°.

👉 NOTE!

Example:

Camera head facing vertically upwards: + 90°

Camera head facing vertically downwards: -90°

Camera head is aligned parallel to the ground above: 0°

Distance counter

The distance indicated at the lower left shows how many meters of the rod are already pulled out of

the case.

You can select the unit meter or feet in the menu, see section **Fehler! Verweisquelle konnte nicht gefunden werden.**

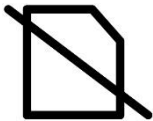


NOTE!

Briefly press the ON/OFF key to reset the distance counter to zero. This may be reasonable at the beginning of the pipe.

Time and date

8.4 Memory Card Missing



The time and date are displayed in the bottom right corner. The recorded time is displayed when the video is played back.

If no memory card is plugged into the card slot, a crossed out memory card icon will appear on screen. The icon will disappear, as soon as the memory card will be inserted.

8.5 Home Function (only Wöhler VIS 350)

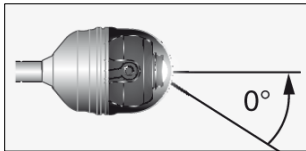


Fig. 28: Home function

The home function ensures the camera head is automatically aligned to a straight position, ensuring the camera "looks straight ahead".

Moreover, when the user presses the HOME key, the camera head aligns itself so that the display is parallel with the ground above (this function is deactivated if the camera head faces 90° upwards or downwards. Under these circumstances, the optics can only be guided forwards).



NOTE!

To determine the grade described under paragraph 8.3.1, the camera head must be aligned straight.



- To activate the home function, press the SHIFT key and then the HOME key.

8.6 Video Record (Wöhler VIS 250 / 350)

Record video



- To begin recording a video, press the Record video key.

The RECORD VIDEO key is framed by a red flashing light when recording is in process, and a red dot is displayed on the screen.

- To stop recording, press the Record video key again. The video is stored in ASF format on the memory card.



CAUTION!

Ensure the power supply is not interrupted when recording a video.

8.7 Video playback (Wöhler VIS 250 / 350)

Video playback





- To playback a recorded video, press the SHIFT key and then the PLAY key. The first image of the last video recorded is displayed on the screen.



NOTE!

It is possible to distinguish a photo from the initial image of a video by the recording time which is displayed in the initial image of a video.

Select the desired video using the right/left arrow keys.

- To begin playing back the video, press the Play key .
- To interrupt the video playback, press again SHIFT + .
- To stop the video playback press SHIFT + Left arrow key
- Press the ON/OFF key to return to the normal mode.
- In play mode press the up arrow to fast forward the video (double speed). 2x will appear on screen.
- Press the up arrow again to forward the video faster. 4x will appear on screen.
- Press the down arrow to return to double and then to normal speed.

Fast- forward and rewind



9 Images (Wöhler VIS 250 / 350)



- To capture an image, press the SHIFT key and then the PHOTO key.

The image is saved as a .jpg file on the memory card.

10 Delete a Video or an image (Wöhler VIS 250 / 350)




- To select the file to be deleted, press the SHIFT key and then the PLAY key.

The first image of the last video recorded or the last image recorded is displayed on the monitor.



Note!

It is possible to distinguish a photo from the initial image of a video by the recording time which is displayed in the initial image of a video.

- Select the video or image to be deleted using the right/left arrow keys.
- To delete the video, press the SHIFT key and then the DELETE key .



The prompt "DELETING FILE" is displayed on the screen for approximately 2 seconds. Once the file has been deleted, the image currently being transmitted from the camera head is displayed on the screen.

11 Transferring and showing images and videos (Wöhler VIS 250 /350)

- 11.1 Transferring to the PC** Two options are available to transfer image files (.jpg) and video files (ASF):
- Read in the files on a PC from the SD memory card or
 - Transfer the files to the PC using the USB cable.
- 11.2 Replaying videos on the PC** To playback a video on the PC the Windows Media Player can be used.

12 Guide accessories

This section contains some recommendations based on our experience about the selection of guide accessories for the inspection in tubes and ducts.

As all pipes and chimney systems are different, the user has to decide about the guide accessory in every single case. For the selection of the correct tool it is important to consider that the guide accessory has to facilitate the introduction and the extraction of the camera head, as well as an adequate guidance. The danger of jamming or getting stuck in the tube has to be avoided.



NOTE!

The information given in this section only refers to the accessories.




NOTE!

The information given in this chapter only refers to the accessories. Chapter 3 explains which camera system can be used in which tube.

Ø 40 - 50 mm	Use the service camera without accessories.
Ø 50 – 70 mm	You can use the service camera without accessories. The lens can be protected by a guidance sleeve. If there is water and mud in the horizontal part, we recommend to use the roller guide.
Ø 70 – 100 mm	The inspection is possible with the roller guide and without it. Use the guidance weight for the vertical inspection or for the inspection of downpipes.
Ø 100 – 154 mm	A centering brush can be used with the roller guide or without it and with the lens protection.

13 Faults

Fault description	Possible cause	To rectify
Cannot start monitor. When the ON/OFF key is pressed, the light framing the key briefly lights up red.	Rechargeable battery has no charge left.	Recharge battery or connect monitor to electrical power supply.
Battery status indicator on the monitor indicates a low battery charge.	Rechargeable battery has no charge left..	Replace (only Wöhler VIS 350) or recharge batteries.
The monitor is off, but the LEDs of the camera head are shining.	The monitor is not connected correctly.	Plug in the monitor plug.
Monitor displays black and white	Minimal colour intensity is set.	Adjust the colour intensity of the monitor with key 4 
Wöhler VIS 300/350: bad image	Plastic dome scratched.	Replace the plastic dome; glass dome optional.
Camera head or monitor freezes	Battery / rechargeable battery flat.	Replace (only Wöhler VIS 350) or recharge batteries.
	Device is faulty.	Send camera system in for repair.
Blue screen, NO SIGNAL displayed on the monitor	Rod is broken.	Send camera system in for repair.
	Cable/plug connection at monitor not properly connected.	Reconnect the plug connection. Broken cables in plug connection. Send camera system in for repair.
Distance measurement/Date/time do not appear in the display any more.	System error	Remove rechargeable battery and power supply. After one minute and insert the battery again.

14 Maintenance

14.1 Regular maintenance

Proper operation of the camera system requires regular maintenance. The following maintenance works can be done by the user himself.

14.2 Changing the dome of the Camera Head Wöhler VIS 300/350

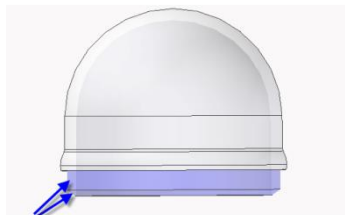


Fig. 29: Fitting the camera dome



NOTE!

The Wöhler Camera Head VIS 300/350 is supplied ex-works protected by a plastic dome, which can be replaced if necessary. If it becomes scratched, it is optional to fit this camera head with a glass dome for use in dry working environments.

Apply silicone grease before fitting the new dome. When fitting the replacement dome, make sure you cover all of the thread to ensure it is properly tightened. Otherwise, it cannot be guaranteed that the camera head is properly sealed, and malfunctions can occur as a result of water and dirt penetration.

14.3 Camera head

- Only use soft, damp cloth to clean the lens. Never use any cleanser.

14.4 Push rod

- Regularly pull the rod out of the case and clean it with a soft, damp cloth.

14.5 Monitor

- Clean the monitor using a soft cloth.

15 Warranty and service

- 15.1 Warranty**
- Each Wöhler VIS 200/250/300/350 will be tested in all functions and will leave our factory only after extensive quality control testing.
- If used properly, the warranty period for the VIS 200/250/300/350 will be 12 month from the date of sale. Not covered by the warranty is the plastic dome VIS 3xx.
- This guarantee does not include the costs for transport and packing material in case of repair.
- Service by non authorized personnel or making modifications on the service camera voids any warranty.
- 15.2 Service**
- Wöhler has built our reputation on excellence in customer service. Therefore, of course, we are readily available to assist you after the guarantee period ends.
- Send us the device, and we will repair it and return it to you with our package service.
 - Immediate help is provided by our technical staff over the telephone.

16 Accessories

Wöhler VIS Guidance Set 70 for miniature camera head Ø 26 mm	Order No. 3883 J
Wöhler VIS Centering Brush Extension	Order No. 3853 J
Camera Roller Guide	Order No. 3681 J
Wöhler Protection Sleeve for camera head Ø 40 mm	Order No. 2641 J
Wöhler Guidance Weight 740 g, stainless steel	Order No. 3857 J
Wöhler Guidance Ball	Order No. 3634 J
Wöhle Glass Dome for camera head Ø 40 mm	Order No. 3674 J
Wöhler Replacement Plastic Domes (10 pcs.) for camera head Ø 40 mm	Order No. 3675 J
Anti Slide mat	Order No. 56037 L
Guidance Sleeve with protection cage for Wöhler camera head Ø 26 mm	Order No. 3847 J
Wöhler additional glare protection for monitor	Order No. 6814 J
Wöhler L 200 Locator (Receiver)	Order No. 7430 J
Car charger Wöhler VIS 2xx/3xx	Order No. 3169 J

17 Declaration of conformity EC

WÖHLER Messgeräte Kehrgeräte GmbH
Schützenstr. 41, D-33181 Bad Wünnenberg

Declares that the following product:

Name: Wöhler Service Camera

Model: Wöhler VIS 200 / 250 / VIS 300 / VIS 350

Complies with the safety requirements set out in the directives of the European parliament and council on the approximation of laws of the Member States relating to electromagnetic compatibility (204/108/EC) and low voltage (2006/95/EC).

The following standards were used to access the products in terms of electromagnetic compatibility:

EN 55024
EN 55022 Klasse B

Points of sale and service

Germany

Wöhler Messgeräte Kehrgeräte GmbH

Schützenstr. 41
33181 Bad Wünnenberg
Tel.: +49 2953 73-100
Fax: +49 2953 73-96100
info@woehler.de
www.woehler.de

Wöhler West

Castroper Str. 105
44791 Bochum
Tel.: +49 234 516993-0
Fax: +49 234 516993-99
west@woehler.de

Wöhler Süd

Gneisenaustr.12
80992 München
Tel.: +49 89 1589223-0
Fax: +49 89 1589223-99
sued@woehler.de

International

USA

Wohler USA Inc.
5 Hudchinson Drive
Danvers, MA 01923
Tel.: +1 978 750 9876
Fax.: +1 978 750 9799
www.woehlerusa.com

Czech Republic

Wöhler Bohemia s.r.o.
Za Naspem 1993
393 01 Pelhrimov
Tel.: +420 5653 49011
Fax: +420 5653 23078
info@woehler.cz

Italy

Wöhler Italia srl
Corso Libertà 9
39100 Bolzano
Tel.: +390471402422
Fax: +39 0471
www.woehler.it

France

Wöhler France SARL
16 Chemin de Fondeyre
31200 Toulouse
Tel. : 05 61 52 40 39
Fax : 05 62 27 11 31
info@woehler.fr
www.woehler.fr

Your contact: