

### Remote Visual Inspections



- Videoscopes
- Fiberscopes
- Rigid Borescopes

# Olympus industrial endoscopes satisfy various demands for remote visual inspections in diverse industries.

Olympus is a world-renowned leader in remote visual inspection technology with a comprehensive portfolio of industrial endoscopes that facilitate accurate inspections of small, enclosed spaces. These endoscopes can be used for a wide range of industries and applications.

## Application examples

### ■ Aerospace

Airframe examinations, inspection of turbine blades and combustion chambers, and research, development and production of rocket engines.

### ■ Power Generation

Maintenance of heat exchanger pipes, condensers, piping and turbines in nuclear/ thermal power generation plants, and gearboxes of wind power generation facilities.

### ■ Oil/Gas/Chemical Plants

Routine and urgent inspection of process piping, pressurised storage reservoirs, heat exchangers, boilers, etc.

### ■ Automotive

Quality control examination of engines, hydraulic components, injection nozzles, as well as final inspection of assemblies.

### ■ Defense/Security

Maintenance of military aircraft, as well as for detection of narcotics and other contraband items, and search of victims who may be trapped as the result of various disasters.

### ■ Architecture/Construction

Examination of walls, ducts, structural joints of bridges and constructions.

### ■ Manufacturing

Monitoring operation of equipment and factory automation through automatic inspection and positioning, as well as R&D applications.



<b>Industrial Videoscope IPLEX Series</b> .... P.4-9	<b>Accessories</b> ..... P.17-19
<b>Industrial Fiberscopes</b> ..... P.10-11	<b>Inspection Magnification Charts</b> ..... P.20-21
<b>Industrial Rigid Borescopes</b> ..... P.12-14	<b>System Charts</b> ..... P.22-23
<b>Light Sources</b> ..... P.15-16	

# A Variety of Lineup to Suit Your Specific Requirements

## Industrial Videoscopes



Compact endoscope systems with outstanding functionality, simple operation, and proven durability.

Industrial endoscopes feature a high-resolution image sensor positioned at the objective end, and matched to our precision lenses to deliver bright, colour-rich images. Advanced LED or laser diode illuminations provide optimum brightness to the inspection area. The compact and lightweight videoscopes achieve high quality inspections at any site, featuring versatile functionality and proven reliability under demanding circumstances.

### Structural drawing of insertion tube

#### ► IPLEX FX/ IPLEX UltraLite/ IPLEX LX/ IPLEX LT/ IPLEX MX II

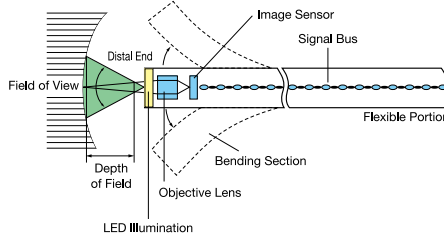

#### ► IPLEX RX/ IPLEX RT/ IPLEX YS/ IPLEX TX

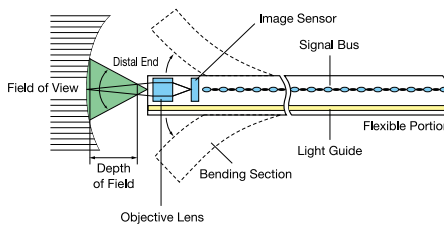

## Industrial Fiberscopes



Flexible endoscopes for simple observations through an eye piece. Observation on a monitor is available by connecting to a CCD camera.

### Structural drawing

#### ► Industrial Fiberscopes

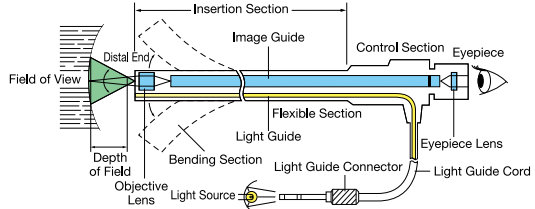

## Industrial Rigid Borescopes



Where straight-line access to the inspection area is possible, providing effective and cost-efficient inspections.

### Structural drawing

#### ► Standard Rigid Borescopes/ Swing-prism Borescopes/ Zoom Swing-prism Borescopes/ Engine Borescopes

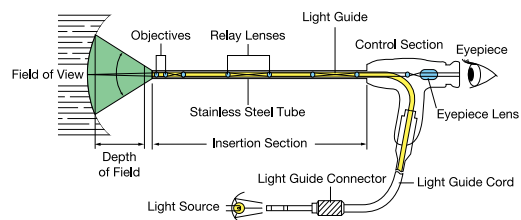

#### ► MK Modular Mini-Scopes

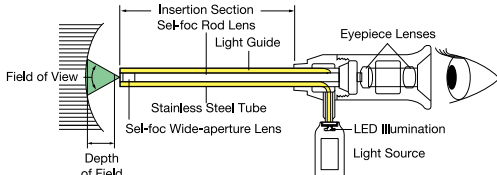



# Industrial Videoscopes IPLEX Series

The IPLEX industrial videoscopes provide excellent performance at various inspection sites, featuring exceptional image quality and advanced functionality yet being portable and user-friendly designs.

## Product Lineup

### IPLEX FX

This high-end industrial videoscope system combines portability with performance; modularity with reliability; simplicity with advanced functionality; and ease of use with durability.

- Interchangeable scopes covering various inspection applications with a single IPLEX FX
- Internal working channel scope available for foreign object retrieval
- MIL-STD and IP55 compliant instrument withstanding severe environments
- Stereo Measurement capability



### IPLEX RX/IPLEX RT

Featuring unsurpassed image quality yet userfriendly, and boasting portable design. Ideal for inspectors who require uncompromised and precise inspections.

- Overwhelmingly bright and high-quality image by the unique PulsarPic image processor and new LED illumination system
- Extensive image adjustment options for optimum inspections\*1
- Compact, multi-positioning design for comfortable transport and inspection
- Heavy duty system complying with MIL-STD and IP55
- Stereo Measurement capability\*2

\*1 IPLEX RX only.

\*2 Optional function for IPLEX RX.



### IPLEX UltraLite

The palm-sized industrial videoscope, weighing just 700 g, delivers high quality images. Its compact, durable body enables inspections in tough and confined areas, dramatically improving your field inspections.

- Surprisingly compact and lightweight
- Ergonomic design fitting snugly into your palm
- Resistant to rain, dust, and physical shock complying with IP55
- Stereo Measurement capability\*

\* Available on Stereo Measurement model.



### IPLEX TX

The ultra-thin 2.4 mm diameter videoscope with articulation reaches inside almost any narrow or winding area, clearly bringing out tiny defects.

The IPLEX TX is ideal for routine inspections of castings, moulds, and other parts with small cavities.

- Ultra-thin, 2.4 mm diameter scope with 2-way articulation
- Bright and clear images using unique WiDER™ image processing
- Dust- and rain-proof casing with the abrasion resistant scope



## IPLEX YS\*

Extra-long 30 m scope is equipped with innovative laser illumination and scope articulation technology to ensure great image quality and manoeuvrability even during an inspection of deeper areas. The IPLEX YS is optimal for extra-long pipe inspections.

- Innovative air articulation technology enabling scope articulation at any length
- Revealing a location of target with gravity sensor and length indicator
- Air jet blows away dust on the scope tip
- Pioneering laser diode illumination for exceptional brightness
- Stereo Measurement capability

\* Built-to-order



## IPLEX LX / IPLEX LT

The 8.5 mm outer diameter scope is suitable for large space inspections, featuring excellent brightness and scope insertion capability.

- The 8.5 mm diameter scope with ideal stiffness and thickness for long reach
- Bright illumination suitable for large void inspections
- Compact, multi-positioning design for comfortable transport and inspection
- Resistant to rain, dust, and physical shock complying with IP55
- Stereo Measurement capability\*

\* Optional function for IPLEX LX.



## IPLEX MX II

With a simple design dedicated for direct-view inspections, the IPLEX MX II is a basic inspection tool for entry level users.

- Compact, multi-positioning design for comfortable transport and inspection
- Durable yet manoeuvrable scope with optimised stiffness and flexibility
- Easy-to-use regardless of users' experience levels



# Main Features of IPLEX Series

## Fulfilling scope lineup

The IPLEX series offers a wide selection of scopes to satisfy your diverse inspection needs. You can select optimal scopes of the lengths from 1.2 m to 30 m with 2.4 mm, 4.0 mm, 6.0 mm or 8.5 mm diameters. Additionally, internal working channel scopes are also available on IPLEX FX in which various retrieval tools can be mounted to facilitate foreign object retrieval and hook-and-drag engine inspections.

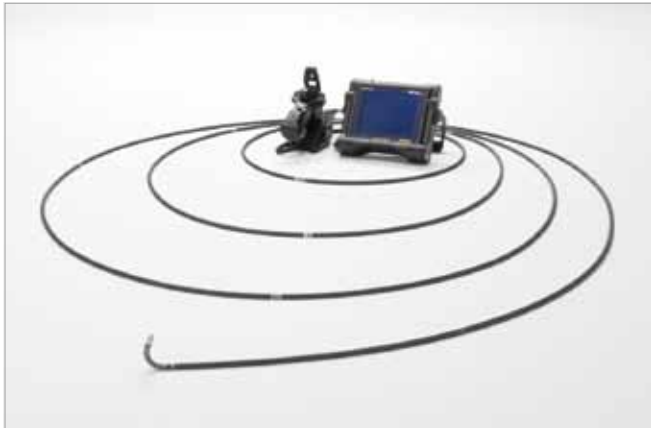

## High quality image

### Interchangeable optical adaptors\*1

For optimum magnification and direction depending on inspection environments, the IPLEX series provides a comprehensive range of interchangeable optical adaptors.

\*1 Applicable models: IPLEX FX/ IPLEX RX/ IPLEX RT/ IPLEX LX/ IPLEX LT/ IPLEX UltraLite/ IPLEX YS



## Image adjustment functions

The IPLEX series features advanced image adjustment functions. Zooming and brightness adjustment are available, and Olympus' unique WiDER™ image processing technology\*2 delivers bright, contrast-balanced images across the entire depth of field.

\*2 Applicable models: IPLEX FX/ IPLEX RX/ IPLEX RT/ IPLEX LX/ IPLEX TX/ IPLEX YS

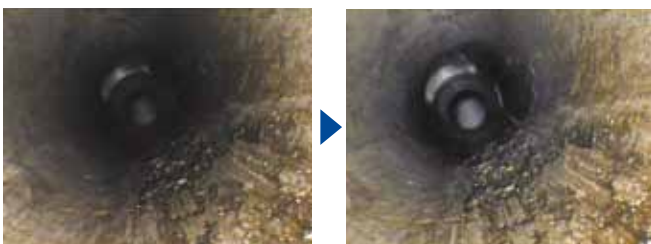

Image at standard gain setting

With WiDER™ gain setting

## Digital image and voice annotation recording

The IPLEX series has the capability to record images as still images and movies\*3 in high quality, into a connected recording medium. Voice annotation is also available with IPLEX FX and IPLEX YS.

\*3 Applicable models: Still image recording - All models of the IPLEX series, Movie recording - IPLEX FX/ IPLEX RX/ IPLEX RT/ IPLEX LX/ IPLEX LT/ IPLEX UltraLite/ IPLEX TX/ IPLEX YS



## Ease of use

### Portable design

The compact IPLEX series driven by internally mounted Lithium-ion battery can be carried to difficult-to-access sites. With its all-in-one design, you can start operation by pressing the power button.



## Smooth and accurate approach to objects

The 4-way articulation controller\*4 of the IPLEX series features precise and quick scope tip articulation with light touch operation, achieving smooth navigation through intricate paths. The insertion tube is designed with the unique Tapered Flex™\*5 to optimise both the scope stiffness and flexibility for excellent scope manoeuvrability.

\*4 The IPLEX TX provides 2-way articulation.

\*5 Applicable models: IPLEX FX/ IPLEX RX/ IPLEX RT/ IPLEX LX/ IPLEX LT/ IPLEX UltraLite/ IPLEX MX II. Reference page 8 for more details.



## Durability

### All weather resistance with rugged body

The IPLEX series can be used in rain, sand and dust, and withstands physical shocks caused by drops and falls, ensured by IP55 and/or MIL-STD\*6. The superb reliability offers you confident inspections even under harsh environments.

\*6 Applicable models: IPLEX FX/ IPLEX RX/ IPLEX RT/ IPLEX LX/ IPLEX LT/ IPLEX UltraLite/ IPLEX TX



### Abrasion and crush resistant insertion tube

The crush-proof insertion tubes of the IPLEX series are equipped with an innovative fine mesh tungsten outer braid\*7 that results in outstanding abrasion resistance, allowing operation in the most difficult and hazardous inspection areas.

\*7 IPLEX TX is equipped with a special resin tube.



## Advanced functionality

### Stereo measurement Capability\*8

Our Stereo Measurement technology offers defect measurements from various angles with simple operations. With diverse measurement modes including distance, height and depth, the Stereo Measurement enables quantitative defect diagnosis.

\*8 Available models: IPLEX FX/ IPLEX RX/ IPLEX LX/ IPLEX UltraLite/ IPLEX YS. Reference page 8 for more details.



Depth measurement accomplished with the Stereo Measurement

### InHelp™ inspection assist software\*9

InHelp, the inspection data management and reporting software, streamlines many aspects of remote visual inspections with the IPLEX series, greatly improving work efficiency and simplifying inspections.

\*9 Available models: IPLEX FX/ IPLEX RX/ IPLEX RT/ IPLEX LX/ IPLEX LT/ IPLEX UltraLite. The InHelp is equipped on the IPLEX RX and IPLEX RT as standard.



Wireless LAN  
Capability Ready

Confirmed with Toshiba  
FlashAirWireless LAN SD card





# Specifications

## Videoscope Features and Functions

	IPLEX FX	IPLEX RX	IPLEX RT *1	IPLEX LX	IPLEX LT *2	IPLEX UltraLite	IPLEX TX	IPLEX YS	
<b>Scope Variation</b>									
<b>Outer diameter</b>	<b>Insertion tube length</b>		<b>Product code</b>						
ø2.4 mm	1.2 m						IV8212T		
ø4.0 mm	2.0 m	IV8420	IV9420RX	IV9420RT		IV8420U			
	3.5 m	IV8435	IV9435RX	IV9435RT		IV8435U			
ø4.4 mm	1.5 m								
	3.0 m								
ø6.0 mm	2.0 m	IV8620	IV9620RX	IV9620RT		IV8620U			
	3.0 m								
	3.5 m	IV8635	IV9635RX	IV9635RT		IV8635U			
	5.0 m	IV8650	IV9650RX	IV9650RT					
	7.5 m	IV8675	IV9675RX	IV9675RT					
	12.0 m	IV86120*3							
ø6.2 mm	3.5 m	IV8635X1 (with internal channel)							
	3.5 m				IV8835L1	IV8835L2			
ø8.5 mm	10.0 m				IV88100L1	IV88100L2			
	20.0 m				IV88200L1*3	IV88200L2*3			
	30.0 m							IV88300Y*3	
<b>Basic Functions</b>									
Angulation directions			Up-down/Right-left			Up-down		Up-down	
Angulation range	IV8420 - 130°		IV9420RX - 130°		IV9420RT - 130°		IV8835L1 - 140°		
	IV8435 - 130°		IV9435RX - 130°		IV9435RT - 130°		IV88100L1 - 115°		
	IV8620 - 150°		IV9620RX - 150°		IV9620RT - 150°		IV88200L1 - 70°		
	IV8635 - 130°		IV9635RX - 130°		IV9635RT - 130°		IV88200L2 - 70°		
	IV8635X1 - 120°		IV9635RX - 120°		IV9635RT - 120°		IV8635U - 120°		
	IV8650 - 110°		IV9650RX - 100°		IV9650RT - 100°				
	IV8675 - 90°								
Angulation control	TrueFeel™ electronic power assisted					Joystick manual controlled	Direct manipulation	Pneumatic pressure	
Insertion tube	Exterior	High durability tungsten braid					High durability resin tube with special processing	High durability	
	Tube flexibility	IV94 and IV84 series - Uniformed stiffness, IV96 and IV86 and IV88 series*4 - Tapered Flex™ tube					Uniformed stiffness		
Interchangeable optical adaptor*5	✓	✓	✓	✓	✓	✓	N/A	✓	
SmartTip™ automatic tip adaptor recognition technology	✓	N/A	N/A	✓*6	N/A	✓*6	N/A	N/A	
Harsh environment resistance	Drop-, water- and dust-proof (complies IP55 and Military Standard)*7					Drop-, water- and dust-proof (complies IP55)		N/A	
Gravity sensor	N/A	N/A	N/A	N/A	N/A	N/A	N/A	✓	
Lens cleaning function	N/A	N/A	N/A	N/A	N/A	N/A	N/A	✓	
High temperature alert	✓	✓	N/A	✓	N/A	✓	N/A	✓	
Interchangeable scope unit	✓	N/A	N/A	N/A	N/A	N/A	✓	N/A	
Working channel	✓*8	N/A	N/A	N/A	N/A	N/A	N/A	N/A	
LCD monitor	6.5" VGA, daylight-view					3.7" VGA		6.5" VGA, daylight-view	
Light source	LED							Laser diode	
Power Supply	AC	100-240 V, 50/60 Hz							
	DC	14.8 V	10.8 V			7.2 V	10.8V	14.8 V	
Dimensions (including protrusions)	Base unit	250 (W) X 160 (D) X 285 (H) mm		239 (W) X 99 (D) X 215 (H) mm		120 (W) X 190 (D) X 190 (H) mm	239 (W) X 99 (D) X 215 (H) mm	472 (W) X 380 (D) X 522 (H) mm	
	Control unit	311 (W) X 92 (D) X 192 (H) mm		365 (W) X 93 (D) X 192 (H) mm		311 (W) X 92 (D) X 192 (H) mm			
Weight (approx.)	6.6 kg with battery (IV8420)	2.9 kg with battery (IV9420RX)	2.9 kg with battery (IV9420RT)	2.7 kg with battery (IV8420L1)	2.7 kg with battery (IV8420L2)	0.7 kg with battery (IV8420U)	1.7 kg with battery	26 kg with battery	
<b>CCU functions</b>									
Menu Language selection	English, German, French, Spanish, Italian, Russian, Korean, Simplified Chinese, Traditional Chinese, Japanese								
Exposure control	✓	N/A	N/A	N/A	N/A	✓	N/A	✓	
Digital zoom	✓	✓	✓	✓	✓	✓	✓	✓	
WIDER™ Gain	✓	✓	N/A	✓	N/A	N/A	✓	✓	
Colour/Sharpness adjustment	✓	✓	N/A	N/A	N/A	N/A	N/A	✓	
Image Comparison	✓	N/A	N/A	N/A	N/A	N/A	N/A	✓	
Input/Output Terminal	Video Signal Output	Composite BNC and S-Video		VGA		Composite RCA		N/A	
	Audio Signal Input	ø3.5 mm monaural mini jack		N/A	N/A	N/A	N/A	ø3.5 mm monaural mini jack	
<b>Recording Management functions</b>									
Still image recording file format	JPEG/ TIFF		JPEG				JPEG/ TIFF		
Movie recording file format	AVI M-JPEG		AVI MPEG4				AVI M-JPEG		
Audio recording file format	WAV		N/A		N/A		WAV		
Thumbnail display	✓	✓	✓	✓	✓	✓	✓		
Image title entry	ImageNotepad™		Title only					ImageNotepad™	
Search function	Date search	N/A	N/A	N/A	N/A	N/A	N/A	Date search	
USB terminal	USB version 1.1		USB version 2.0				USB version 1.1		
Recording medium provided as standard	1 GB CF card		1 GB USB flash drive			4GB SDHC Card		1 GB USB flash drive	
Internal Memory	1 GB		N/A		N/A		1 GB		
<b>Measurement functions</b>									
Scaler measurement	✓	N/A	N/A	N/A	N/A	N/A	N/A	✓	
Stereo measurement (Distance)*9	✓	✓*11	N/A	✓*11	N/A	✓*10	N/A	✓	
Stereo measurement (Point-to-Line)*9	✓	✓*11	N/A	✓*11	N/A	✓*10	N/A	✓	
Stereo measurement (Depth)*9	✓	✓*11	N/A	✓*11	N/A	✓*10	N/A	✓	
Stereo measurement (Lines)*9	✓	✓*11	N/A	✓*11	N/A	✓*10	N/A	✓	
Stereo measurement (Area)*9	✓	✓*11	N/A	✓*11	N/A	✓*10	N/A	✓	
Stereo measurement (Multi)*9	✓	N/A	N/A	N/A	N/A	N/A	N/A	✓	
Stereo measurement (Offset)*9	✓	N/A	N/A	N/A	N/A	N/A	N/A	✓	
Stereo measurement (Profile)*9	✓	N/A	N/A	N/A	N/A	N/A	N/A	✓	
Spot-Planging™ (Object distance)*9	✓	✓*11	N/A	✓*11	N/A	✓*10	N/A	✓	

\*1 The IPLEX RT can be upgraded to IPLEX RX. \*2 The IPLEX LT can be upgraded to IPLEX LX. \*3 Built-to-order. \*4 IV86120, IV86180, IV89200L1 and IV89200L2 are not equipped with Tapered Flex™ tube. \*5 The distal end optical adaptor is optional. \*6 The function on the IPLEX UltraLite and IV88 series of the IPLEX LX is limited to recognition of the tip adaptor attachment to the scope only. \*7 IV88 series are not compliant with Military Standard. \*8 Available only for IV8635X1. \*9 Optional stereo adaptors are needed. \*10 Available only for IPLEX UltraLite Stereo Measurement models. \*11 Available on the upgraded IPLEX LX and IPLEX RX only.



IPLEX MXII	
<b>Note</b>	
IV8415M	
IV8430M	
IV8630M	
Right-left	
IV8415M - 120°	
IV8430M - 120°	
IV8630M - 120°	
TrueFeel™ electronic power assisted	
tungsten braid	Tapered Flex™ tube: Insertion tube with flexibility gradually increasing toward the distal end.
Tapered Flex™ tube	
N/A	For the specifications, see "Optical Adaptor Specifications".
N/A	
N/A	Indicating gravity directions of the scope tip
N/A	Cleaning fine drip and dust on the scope tip by blowing air
N/A	
N/A	The IPLEX FX and IPLEX TX consist of the base unit (IV8000-2 for IPLEX FX/ IV8200T for IPLEX TX) and an interchangeable scope unit.
N/A	
LED	IPLEX FX, IPLEX LX and IPLEX UltraLite: 2 stage setting for extra-bright illumination with AC adaptor
10.8 V	with specified Lithium-ion battery
239 (W) X 99 (D) X 215 (H) mm	
230 (W) X 100 (D) X 200 (H) mm	
2.5 kg with battery (IV8415M)	

N/A	1/2 to 1/30000 sec(NTSC), 1/2 to 1/25000 sec(PAL)
√	
N/A	WIDER™ image processing algorithm greatly expands the dynamic range to bring out details in shadows and highlights.
N/A	
N/A	Live image and retrieve image are displayed on half-split screen.
Composite RCA	
N/A	
JPEG	
N/A	
N/A	Recording time: MAX 60 sec
N/A	
Title only	Title: Up to 30 characters ImageNotepad™: Enables to insert up to 10 descriptions, displayed by categories and contents in addition to the title input.
N/A	
USB version 2.0	
1 GB USB flash drive	
N/A	
N/A	Measures the distance between points. The calculation is based on the known length in the same inspection image.
N/A	Measures the distance between the two plotted points.
N/A	Measures the distance between a hypothetical line between two designated positions and the required point.
N/A	Measures the depth/height from a hypothetical plane inside three designated positions to the required point.
N/A	Calculates the distance among multiple designated positions (Max 20 points).
N/A	Calculates the area surrounded by multiple designated positions (Max 20 points).
N/A	Automatically detects and measures damaged width/depth/area between two specified spots.
N/A	Point-to-Line measurement with a parallel line passing on a measurement point.
N/A	The cross section of two designated points is represented with computer graphics.
N/A	Measures object distance between tip of scope and cursor.

## Optical Adaptor Specifications

Model	Scope	Optical Adaptor	Outer diameter	Optical System			
				Field of view	Direction of view	Depth of field*1	
IPLEX FX IPLEX LX IPLEX LT IPLEX UltraLite	IV84	AT120D/NF-IV84	ø4.0 mm	120°	Forward	4 to 190 mm	
		AT120D/FF-IV84				25 to ∞ mm	
		AT120S/NF-IV84			Side	1 to 20 mm	
		AT120S/FF-IV84				6 to ∞ mm	
	IV86	AT40D-IV86	ø6.0 mm	40°	Forward	200 to ∞ mm	
		AT80D/NF-IV86				8 to ∞ mm	
		AT80D/FF-IV86		35 to ∞ mm			
		AT120D/NF-IV86		120°		4 to 190 mm	
		AT120D/FF-IV86				25 to ∞ mm	
		AT80S-IV86		80°		18 to ∞ mm	
	AT120S/NF-IV86	120°	1 to 25 mm				
	AT120S/FF-IV86		5 to ∞ mm				
IPLEX FX IPLEX LX IPLEX UltraLite*2	IV84	AT50D/50D-IV84	ø4.0 mm	50°/50°	Forward /Forward	5 to ∞ mm	
		AT50S/50S-IV84			Side/Side	4 to ∞ mm	
	IV86	AT60D/60D-IV86	ø6.0 mm	60°/60°	Forward /Forward	5 to ∞ mm	
		AT60S/60S-IV86			Side/Side	4 to ∞ mm	
		AT80D/FF-IV94		80°	Forward	35 to ∞ mm	
		AT120D/NF-IV94				2 to 200 mm	
IPLEX RX IPLEX RT	IV94	AT120D/FF-IV94	ø4.0 mm	120°	Forward	17 to ∞ mm	
		AT100S/NF-IV94				2 to 15 mm	
		AT100S/FF-IV94		100°		Side	8 to ∞ mm
		AT40D-IV96					ø6.0 mm
	AT80D/NF-IV96	9 to ∞ mm					
	AT80D/FF-IV96	35 to ∞ mm					
	AT120D/NF-IV96	120°	Forward	2 to 200 mm			
	AT120D/FF-IV96			19 to ∞ mm			
	AT80S-IV96	80°	Side	15 to ∞ mm			
	AT120S/NF-IV96			120°	1 to 25 mm		
	AT120S/FF-IV96	3 to ∞ mm					
	IPLEX RX	IV94	AT50D/50D-IV94	ø4.0 mm	50°/50°	Forward /Forward	5 to ∞ mm
AT50S/50S-IV94			Side/Side			4 to ∞ mm	
IV96		AT60D/60D-IV96	ø6.0 mm	60°/60°	Forward /Forward	5 to ∞ mm	
		AT60S/60S-IV96			Side/Side	4 to ∞ mm	
IPLEX FX	IV8635X1	AT120D/NF-IV86X1	ø6.2 mm	120°	Forward	4 to 190 mm	
		AT120D/FF-IV86X1				25 to ∞ mm	
		AT80S-IV86X1		80°		Side	18 to ∞ mm
		AT120S-IV86X1					6 to ∞ mm
		AT60D/60D-IV86X1		60°/60°		Forward /Forward	5 to ∞ mm
		AT60S/60S-IV86X1					Side/Side
IPLEX LT IPLEX LX	IV88	AT80D/FF-IV88	ø8.5 mm	80°	Forward	35 to ∞ mm	
		AT120D/NF-IV88				4 to 190 mm	
		AT120D/FF-IV88		120°		Side	25 to ∞ mm
		AT120S/NF-IV88					1 to 25 mm
		AT120S/FF-IV88		5 to ∞ mm			
IPLEX LX	IV88	AT60D/60D-IV88	ø8.5 mm	60°/60°	Forward /Forward	5 to ∞ mm	
		AT60S/60S-IV88			Side/Side	4 to ∞ mm	
IPLEX TX	IV8212T	—	ø2.4 mm	80°	Forward	3 to 70 mm	
IPLEX YS	IV8300Y	AT120D/NF-IV88Y	ø8.5 mm	120°	Forward	4 to 190 mm	
		AT120D/FF-IV88Y				25 to ∞ mm	
		AT120S/NF-IV88Y		80°		Side	1 to 25 mm
		AT120S/FF-IV88Y					5 to ∞ mm
		AT60D/60D-IV88Y		60°/60°		Forward /Forward	5 to ∞ mm
		AT60S/60S-IV88Y					Side/Side
IPLEX MX II	IV84	—	ø4.4 mm	100°	Forward	12 to 50 mm	
	IV86	—	ø6.0 mm	120°		18 to 1,000 mm	

\*1 Indicates the viewing distance with optimal focus.  
\*2 Available only for IPLEX UltraLite Stereo Measurement models.

## Operating Environment

		IPLEX FX	IPLEX RX	IPLEX RT	IPLEX LX	IPLEX LT	IPLEX UltraLite	IPLEX TX	IPLEX YS	IPLEX MX II
Operating temperatures	Insertion tube	In air	-25 to 100°C	-25 to 100°C	-25 to 80°C	-25 to 80°C	-25 to 100°C	-25 to 80°C	-25 to 100°C	-25 to 80°C
		Underwater	10 to 30°C							
	Other parts	In air	-21 to 49°C (with battery) 0 to 40°C (with AC adaptor)	-10 to 40°C (with battery) 0 to 40°C (with AC adaptor)						
Liquid resistance		No trouble even when machine oil, light oil or 5% saline is attached.								
Waterproofing	Water pressure in depth (Insertion tube)*	7.5 m	IV94: 3.5 m IV96: 7.5 m	IV88: 10.0 m	3.5 m	1.2 m	30.0 m	3.0 m		
	Other parts	Rain-proof: can be used in rain as long as the battery cover and others are close but cannot be used underwater.							Neither waterproof nor rain-proof.	

\*Excluding IV8635X1. Not operable underwater with stereo measurement adaptors.

# Industrial Fiberscopes

Providing simple and cost-effective inspections of objects located in deep, small and enclosed areas.



## Main Features

### High Resolution

Original Olympus high-performance optics technology, using high-density glass fibre bundles, offers the world's highest level of fibrescopic resolution and bright, sharp images.

### Tapered Flex™ Tube with Superior Insertability\*1

IF5 Series scopes employ the Tapered Flex™ tube. Ideal for insertion into multiple-bend pipes, the insertion tube's flexibility changes continuously, being highly flexible at the tip and rigid at the control section. As a result, IF5 Series scopes can easily be passed through bends and elbows.

At the same time, the gradually increasing rigidity of tube as it approaches the control section assures easier transmission of pushing/twisting strength after the first bend.

\*1 Excluding IF2D5.

### Tip Articulation\*2

The distal end can be angled in either two or four directions, by handheld controls.

\*2 Excluding IF6PD4.

### Interchangeable Optical Adaptors\*3

Facilitate a wide variety of viewing angles and directions in just one scope.

\*3 Excluding IF6PD4, IF2D5, IF4D5, IF4S5.

### Fully Waterproof Insertion Tube

The insertion tubes of Olympus' industrial fibrescopes are water-proof\*4, and can be used for inspections of underwater objects.

\*4 Excluding IF6PD4.

### Photo and Video Documentation

Video recording and photography are available by connecting a CCD camera or the Olympus digital camera.

## Product Lineup

### Industrial Fiberscopes

#### IF6C5X1/IF8C5/IF11C5

##### Standard Fiberscopes with Excellent Views

- The distal end can be bent in four directions by handheld operation.
- The Tapered Flex™ tube designed for easy passages through bends and elbows.
- You can change the field of view, direction of view and depth of field by switching the optical adaptor.



### Industrial Fiberscopes

#### IF6PD4/IF2D5/IF4D5/IF4S5

##### Ultra-thin Diameters

- The ultra-thin flexible fiberscopes (0.64 mm diameter in minimum) allow you to inspect inside narrow-diameter hole with 1 mm or more diameter.



### Industrial Fiberscopes

#### IF5D4X1-14

##### Specifically for PT-6 Engine Inspection

- Easily change the direction of view by switching the optical adaptor.
- Most suitable for airframe examinations and inspection of turbine blade.
- Authorised by Pratt & Whitney as the fiberscope for PT-6 and ST-6 engine maintenance.



# Specifications

## Fiberscope Features and Functions

		IF6PD4/IF2D5/IF4D5/IF4S5				IF5D4X1-14	IF6C5X1/IF8C5/IF11C5		
		IF6PD4	IF2D5	IF4D5	IF4S5	IF5D4X1	IF6C5X1	IF8C5	IF11C5
<b>Scope variation</b>									
Outer diameter		ø0.64	ø2.4	ø4.1		ø5.0	ø6.0	ø8.4	ø11.3
Effective length	490 mm	IF6PD4-6							
	600 mm		IF2D5-6						
	700 mm			IF4D5-7	IF4S5-7				
	800 mm						IF6C5X1-8		
	990 mm	IF6PD4-11							
	1,000 mm							IF8C5-10	IF11C5-10
	1,170 mm		IF2D5-12						
	1,200 mm					IF5D4X1-14			
	1,300 mm						IF6C5X1-13		
Field of view	1,500 mm			IF4D5-15	IF4S5-15			IF8C5-15	
	2,000 mm						IF6C5X1-20	IF8C5-20	IF11C5-20
	3,000 mm						IF6C5X1-30	IF8C5-30	IF11C5-30
		58°	75°	65°	60°	49°	Convertible using optical adaptor		
Direction of view		Direct viewing			Side viewing	Direct viewing (Convertible to side viewing using optical adaptor)	Direct/Side viewing (Convertible using optical adaptor)		
Depth of field (Fixed focus)		1 to 50 mm	2 to 50 mm	5 to 60 mm	4 to 40 mm	5 to 50 mm	Convertible using optical adaptor		
Bending section		Angulation range		Up-Down 120°			Up-Down 120°, Right-Left 100°		
Illumination system		Light guide system							
Light guide cable length		2,000 mm	2,200 mm			2,000 mm			

## Optical Adaptor Specifications

Scope	Optical adaptor	Field of view	Direction of view	Depth of field		
IF5D4X1-14	Optional	AT50S-IF5D4X1	49°	Side viewing	5 to 50 mm	
	Provided	AT60D/FF-IF6C5	60°	Direct viewing	11 to ∞ mm	
IF6C5X1	Optional	AT30D-IF6C5	30°	Direct viewing	26 to 372 mm	
		AT60D/NF-IF6C5	60°		5 to 102 mm	
		AT100D-IF6C5	100°	4 to ∞ mm		
		AT30S-IF6C5	30°	Side viewing	21 to 138 mm	
	AT60S/NF-IF6C5	60°	4 to 85 mm			
	AT60S/FF-IF6C5	60°	9 to ∞ mm			
	AT100S-IF6C5	100°	4 to ∞ mm			
IF8C5	Provided	AT60D/FF-IF8C5	60°	Direct viewing	20 to ∞ mm	
	Optional	AT30D/NF-IF8C5	30°	Direct viewing	30 to 70 mm	
		AT30D/FF-IF8C5	30°		60 to 250 mm	
		AT60D/NF-IF8C5	60°		9 to 50 mm	
		AT100D/NF-IF8C5	100°		3 to 200 mm	
		AT100D/FF-IF8C5	100°	9 to ∞ mm		
		AT30S-IF8C5	30°	Side viewing	45 to 90 mm	
		AT60S/NF-IF8C5	60°		8 to 40 mm	
		AT60S/FF-IF8C5	60°		20 to 240 mm	
	AT100S/NF-IF8C5	100°	3 to 140 mm			
	AT100S/FF-IF8C5	100°	9 to 200 mm			
	IF11C5	Provided	AT60D/FF-IF11C5	60°	Direct viewing	27 to 390 mm
		Optional	AT30D/NF-IF11C5	30°	Direct viewing	38 to 70 mm
			AT30D/FF-IF11C5	30°		65 to 120 mm
AT60D/NF-IF11C5			60°	11 to 45 mm		
AT100D/NF-IF11C5			100°	5 to 70 mm		
AT100D/FF-IF11C5			100°	16 to 300 mm		
AT30S-IF11C5			30°	Side viewing	55 to 100 mm	
AT60S/NF-IF11C5			60°		11 to 40 mm	
AT60S/FF-IF11C5			60°		28 to 440 mm	
AT100S/NF-IF11C5		100°	3 to 22 mm			
AT100S/FF-IF11C5	100°	12 to 250 mm				

## Operating Environment

		IF6PD4	IF2D5	IF4D5	IF4S5	IF5D4X1	IF6C5X1	IF8C5	IF11C5
Operating temperatures	Insertion tube	In air	10 to 40°C		-10 to 80°C				
		In water	10 to 30°C	10 to 40°C	10 to 30°C		—	10 to 30°C	
	Other parts than above	In air	10 to 40°C		-10 to 50°C				
Liquid resistance (against machine oil, light oil and 5% saline)				✓	✓		✓	✓	✓
Waterproof	Insertion tube		✓	✓	✓	✓	✓	✓	✓
Drip-proof	Control section		✓	✓	✓	✓	✓	✓	✓



# Industrial Rigid Borescopes

Suitable inspections of very small and straight spaces, providing clear and sharp images.



## Ergonomic Control Section

Fits snugly in your hand.

## Versatile Lineup

Close to 200 models available featuring various diameters, working lengths, and viewing directions and angles.



## Main Features

### Clear, High-resolution Images

Excellent detail reproductions. Sharp image is easy on the eyes, helping reduce inspector fatigue.

### Focus Adjustment Mechanism

Easy-to-use focus control.

### 370° Rotation\*1

Upward pointer keeps you oriented when using the rotation function.

\*1 Available for side-viewing scopes of R040, R060, R080, R100 and R120 only.



### Increased Field of View

32% larger field of view in R040 models and 96% larger field of view in R060 models.

### Accurate Image Reproduction

The Olympus' rigid borescopes feature low distortion at image edges.

### Even Illumination

The tip design ensures more even illumination even when viewing close-range subjects.\*2

\*2 Available for side-viewing scopes of R040, R060, R080, R100 and R120 only.

### Outstanding Durability

Stainless steel insertion tube usable at temperatures between -20°C and 150°C as well as under pressure of up to 1.7 atmospheres.\*3

\*3 Excluding MK Modular Mini-scopes and Small Diameter Borescopes

## Product Lineup

### Standard Rigid Borescopes

The stainless steel insertion tube usable at temperatures between  $-20^{\circ}\text{C}$  and  $150^{\circ}\text{C}$ . Close to 200 models available featuring various diameters, working length, and viewing directions and angles.



### Swing-prism Borescopes

The scope's direction of view can be adjusted continuously from fore-oblique to retro viewing – coupled with the field of view, this allows a total viewing arc of  $120^{\circ}$  to  $140^{\circ}$ .



### Zoom Swing-prism Borescopes

The Zoom swing prism incorporates the same characteristics as the standard swing prism, but with the added feature of 2X optical zoom. This allows the user to zoom onto an object of interest, providing a magnified view.



### Engine Borescopes

The Engine borescopes have been designed to meet manufacturer and user specification requirements specifically for a number of key military and commercial aero engines.

### X Series Miniboscopes

Raise your productivity with easy-to-use, highly durable, small diameter borescopes.

- Small diameter (down to 0.9 mm) and wide field of view (up to  $70^{\circ}$ ).
- Clear image transmission via latest fibre technology.
- Separate fibre bundle for illumination of inspection area.



### MK Modular Mini-scopes

1.2 mm, 1.7 mm, and 2.7 mm ultra-thin borescopes for extremely tight spaces. Interchangeable eyepiece and body assembly will reduce the risk of damage and need for repair.



Connectable light sources and light guides differ depending on the rigid borescope models. Please ask our sales representatives for details.

## Operating Environment

		Standard Borescope Swing-prism Borescope Zoom Swing-prism Borescope	MK Modular Mini-scope	X Series Miniboscopes
Operating temperatures	Insertion tube	In air	$-20$ to $150^{\circ}\text{C}$	$-10$ to $80^{\circ}\text{C}$
		Underwater		$10$ to $30^{\circ}\text{C}$
	Other parts than above	In air	$-20$ to $50^{\circ}\text{C}$	$-10$ to $50^{\circ}\text{C}$
Operating atmospheric pressure	Insertion tube	In air	700 to 1700 hPa	710 to 1070 hPa
		Underwater	Up to 1700 hPa	Up to 1070 hPa
	Other parts than above	In air	710 to 1060 hPa	
Liquid resistance			No trouble even when machine oil, light oil or 5% saline is attached.	
Waterproofing	Insertion tube		Waterproof: can be used underwater.	
	Other parts than above		Drip-proof	

# Specifications

## Standard Rigid Borescopes Features and Functions

Product code	Outer diameter	Effective length	Direction of view	Field of view	Depth of field								
R040-021-000-60	ø4.1 mm	21 cm	0°	60°	5 to ∞ mm								
R040-022-045-60		22 cm	45°										
R040-022-090-60		33 cm	90°										
R040-033-000-60			0°										
R040-033-045-60			45°										
R040-033-090-60	90°	ø6.1 mm	50°	5 to ∞ mm									
R060-017-000-50	17 cm				0°								
R060-017-045-50					45°								
R060-017-090-50					90°								
R060-032-000-50	32 cm				0°								
R060-032-045-50					45°								
R060-032-090-50					90°								
R060-047-000-50	47 cm				0°								
R060-047-045-50					45°								
R060-047-090-50					90°								
R060-063-000-50	63 cm				0°								
R060-063-045-50					45°								
R060-063-090-50					90°								
R080-078-090-50	78 cm				ø8.1 mm	50°	5 to ∞ mm						
R080-024-000-50	24 cm							0°					
R080-024-045-50		45°											
R080-024-090-50		90°											
R080-024-110-50		110°											
R080-025-090-35	25 cm	35°	10 to ∞ mm										
R080-028-090-10	28 cm	90°	10°	80 to ∞ mm									
R080-034-090-50	34 cm	110°	50°	5 to ∞ mm									
R080-035-090-35			35 cm	90°				35°	10 to ∞ mm				
R080-044-000-50	44 cm	0°	50°	5 to ∞ mm									
R080-044-045-50		45°											
R080-044-090-50		90°											
R080-044-110-50		110°											
R080-045-090-35	45 cm	35°	10 to ∞ mm										
R080-048-090-10	48 cm	90°	10°	80 to ∞ mm									
R080-054-090-50	54 cm	110°	50°	5 to ∞ mm									
R080-054-110-50					0°								
R080-064-000-50					45°								
R080-064-045-50	64 cm	110°	50°	5 to ∞ mm									
R080-064-090-50					90°								
R080-064-110-50					110°								
R080-065-090-35	65 cm	90°	35°	10 to ∞ mm									
R080-074-090-50	74 cm	ø8.1 mm	50°	5 to ∞ mm									
R080-084-000-50	84 cm				0°								
R080-084-045-50					45°								
R080-084-090-50					90°								
R080-084-110-50	94 cm				110°	50°	5 to ∞ mm						
R080-094-110-50								0°					
R080-104-045-50								45°					
R080-104-090-50	104 cm				90°	50°	5 to ∞ mm						
R080-104-110-50								110°					
R080-124-000-50								0°					
R080-124-045-50	124 cm				45°	50°	5 to ∞ mm						
R080-124-090-50								90°					
R080-124-110-50								110°					
R080-125-090-35	125 cm				90°	35°	10 to ∞ mm						
R080-134-090-35	134 cm				ø8.1 mm	50°	5 to ∞ mm						
R080-144-000-50	144 cm	0°											
R080-144-045-50		45°											
R080-144-090-50	ø10.1 mm	90°	35°	10 to ∞ mm									
R100-025-090-35								25 cm	50°	5 to ∞ mm			
R100-029-090-10								29 cm	10°	115 to ∞ mm			
R100-038-000-50								38 cm	0°	50°	5 to ∞ mm		
R100-039-045-50									45°				
R100-039-090-50								39 cm	90°	35°	10 to ∞ mm		
R100-039-090-35												50°	5 to ∞ mm
R100-039-110-50												110°	
R100-043-090-10								43 cm	10°	115 to ∞ mm			
R100-053-090-50								53 cm	90°	50°	5 to ∞ mm		
R100-053-090-35												35°	10 to ∞ mm
R100-057-090-10												57 cm	10°
R100-066-000-50					66 cm	0°	50°	5 to ∞ mm					
R100-067-045-50					67 cm	45°	35°	10 to ∞ mm					
R100-067-090-35									50°	5 to ∞ mm			
R100-067-090-50	90°	50°	5 to ∞ mm										
R100-081-090-35	81 cm	35°	10 to ∞ mm										
R100-095-045-50	95 cm	45°	50°	5 to ∞ mm									
R100-095-090-50					90°	35°	10 to ∞ mm						
R100-095-090-35					110°	50°	5 to ∞ mm						
R100-095-110-50	99 cm	110°	10°	115 to ∞ mm									
R100-099-110-50					39 cm	90°	35°	10 to ∞ mm					
R120-039-090-35 ILG*					53 cm	ø12.1 mm	90°	35°	10 to ∞ mm				
R120-053-090-35 ILG*	59 cm	0°											
R160-059-000-35 ILG*	101 cm	90°											
R160-059-090-35 ILG*		0°											
R160-101-000-35 ILG*		90°											
R160-101-090-35 ILG*	122 cm	90°	35°	20 to ∞ mm									
R160-122-090-35 ILG*					0°								
R160-143-000-35 ILG*					90°								
R160-143-090-35 ILG*	143 cm	90°											

\* Light guide is fixed.

## Swing-prism Borescopes Features and Functions

Product code	Outer diameter	Effective length	Direction of view	Field of view	Depth of field
R060-023-045SW115-50	ø6.1 mm	23 cm	45 to 115°	50°	5 to ∞ mm
R060-031-045SW115-50		31 cm			
R060-046-045SW115-50		46 cm			
R060-061-045SW115-50		61 cm			
R060-077-045SW115-50		77 cm			
R080-023-045SW115-50	ø8.1 mm	23 cm	45 to 115°	20°	30 to ∞ mm
R080-024-045SW115-20		24 cm			
R080-033-045SW115-50		33 cm			
R080-043-045SW115-50		43 cm			
R080-044-045SW115-20		44 cm			
R080-053-045SW115-50		53 cm			
R080-063-045SW115-50		63 cm			
R080-064-045SW115-20		64 cm			
R080-083-045SW115-50		83 cm			
R080-103-045SW115-50		103 cm			

## Zoom Swing-prism Borescopes Features and Functions

Product code	Outer diameter	Effective length	Direction of view	Field of view	Depth of field
R060-024-045SW115-50ZM25	ø6.1 mm	24 cm	45 to 115°	25 to 50°	5 to ∞ mm
R060-032-045SW115-50ZM25		32 cm			
R060-047-045SW115-50ZM25		47 cm			
R060-062-045SW115-50ZM25		62 cm			
R080-024-045SW115-50ZM25		24 cm			
R080-034-045SW115-50ZM25	ø8.1 mm	34 cm	45 to 115°	25 to 50°	5 to ∞ mm
R080-044-045SW115-50ZM25		44 cm			
R080-054-045SW115-50ZM25		54 cm			
R080-064-045SW115-50ZM25		64 cm			

## Major Engine Range Specifications

The Olympus borescopes are officially approved for the inspections of various military, commercial aero and power generating engines, including the following models.

Engine manufacturer	Engine model
Pratt & Whitney	PW4000/PW2000/JT9D/JT8D/F100
Rolls-royce	RB211/TRENT
GE	GE90/CF34/CFM56/F110

## MK Modular Mini-scopes Features and Functions

Product code	Outer diameter	Effective length	Direction of view	Field of view	Depth of field
MK012-009-000-45	ø1.2 mm	9 cm	0°	45°	1 to ∞ mm
MK012-009-015-53	ø1.2 mm	9 cm	15°	53°	1 to ∞ mm
MK017-009-000-62	ø1.7 mm	9 cm	0°	62°	1 to ∞ mm
MK017-018-000-62	ø1.7 mm	18 cm	0°	62°	1 to ∞ mm
MK017-009-015-80	ø1.7 mm	9 cm	15°	80°	1 to ∞ mm
MK017-018-015-80	ø1.7 mm	18 cm	15°	80°	1 to ∞ mm
MK017-009-090-62	ø1.7 mm	9 cm	90°	62°	1 to ∞ mm
MK017-018-090-62	ø1.7 mm	18 cm	90°	62°	1 to ∞ mm
MK027-018-000-62	ø2.7 mm	18 cm	0°	62°	1 to ∞ mm
MK027-018-015-80	ø2.7 mm	18 cm	15°	80°	1 to ∞ mm
MK027-018-090-62	ø2.7 mm	18 cm	90°	62°	1 to ∞ mm

## X Series Miniboscopes Features and Functions

Product code	Outer diameter	Effective length	Direction of view	Field of view	Depth of field	
X009-006-000-70	ø0.9 mm	6 cm	0°	70°	3.0 to ∞ mm	
X009-006-000-55C				55°	0.8 to 1.6 mm	
X009-006-015-70			15°	70°	3.0 to ∞ mm	
X009-015-000-55C			15 cm	0°	55°	0.8 to 1.6 mm
X009-015-000-70					70°	3.0 to ∞ mm
X009-015-015-70	15°	70°			2.0 to 7.0 mm	
X012-006-000-55C	ø1.2 mm	6 cm	0°	55°	0.8 to 1.6 mm	
X012-006-000-70				70°	3.0 to ∞ mm	
X012-006-015-55C			15 cm	15°	55°	0.8 to 1.6 mm
X012-006-015-70					70°	2.0 to 7.0 mm
X012-015-000-52C					52°	0.8 to 1.6 mm
X012-015-000-70	ø1.7 mm	15 cm	0°	70°	3.0 to ∞ mm	
X012-015-015-70				15°	70°	2.0 to 7.0 mm
X017-015-000-52C			25 cm	0°	52°	1.4 to 2.5 mm
X017-015-000-70					70°	4.5 to ∞ mm
X017-015-015-56C					56°	1.4 to 2.5 mm
X017-015-015-70	ø1.7 mm	15 cm	15°	70°	3.0 to 12.0 mm	
X017-015-090-52C				52°	1.4 to 2.5 mm	
X017-015-090-70			90°	70°	3.0 to 12.0 mm	
X017-025-000-52C					52°	1.4 to 2.5 mm
X017-025-000-70					70°	4.5 to ∞ mm
X017-025-015-56C	ø2.5 mm	25 cm	15°	56°	1.4 to 2.5 mm	
X017-025-015-70				70°	3.0 to 12.0 mm	
X025-015-000-70			15 cm	0°	4.5 to ∞ mm	
X025-015-015-70					15°	3.0 to 12.0 mm
X025-015-090-70					90°	70°
X025-025-000-70	25 cm	0°	4.5 to ∞ mm			
X025-025-015-70			15°	3.0 to 12.0 mm		
X025-025-090-70			90°	70°	3.0 to 12.0 mm	



# Light Sources

Compact LED Light Source

## LED Light Source ILD-3

The LED light source designed for the MK Modular Mini-scope gives superior brightness at reduced power consumption, and the greatly increased LED life offers lower long term cost and reduced environmental impact. With the use of adaptors it can be fitted to a range of scopes, giving our rigid borescopes or fiberscopes a unique portability.



ILD-3 battery version

### Specifications

	ILD-3
Power Supply	3 VDC rechargeable batteries, ILD-C or Accessory Desktop PSU
Dimensions	55mm long x 30mm diameter
Weight	65 g without CR123 battery
Run time	1.5 hours per interchangeable battery or 8 hours at full brightness from the ILD-C.
Colour Temperature	6350 K

Compact LED Light Source

## LED Light Source ILD-2

Directly competing with the high power halogen units in terms of brightness, but only using a fraction of the power – this light source provides a freedom of portability that only LED technology can offer. Coupled with the comprehensive range of scope adaptors available, this lightsource is the most versatile we have ever offered.



### Specifications

	ILD-2
Power Supply	ILD-C or Accessory Desktop PSU
Dimensions	81mm long x 38mm diameter
Weight	108 g
Run time	2.5 hours at full brightness from the ILD-C.
Colour Temperature	5500 K

## Connecting Scope Adaptors for ILD-2 and ILD-3

A range of adaptors to connect the compact light sources to our various rigid borescopes and fiberscopes.



### Adapted Scopes

Light Source	ILD-2	ILD-3
Adapted Scopes via Connecting Scope Adaptors	Standard Rigid Borescopes	Standard Rigid Borescopes
	Swing-Prism Borescopes	Swing-Prism Borescopes
	Zoom Swing-Prism Borescopes	Zoom Swing-Prism Borescopes
	X Series Miniboscopes	X Series Miniboscopes
	Fiberscopes with Olympus Light Guides Engine Borescopes	Fiberscopes with Olympus Light Guides

Note: Adaptors connecting ILD-2 to rigid borescopes from other companies are also available.

Note: MK Modular Mini-scopes are directly connectable to ILD-3.

Battery Control Unit for Compact LED Light Source

## ILD-C

The ILD-C offers brightness control and prolonged run time from its rechargeable internal battery in use with the ILD-2 or ILD-3, negating the need for external power and providing a completely portable light source. The provided desktop power supply will charge the ILD-C at the same time as running the attached ILD-2 or ILD-3, offering continuous use.



### Specifications

	ILD-C
Power Supply	9 to 19 VDC
Power Consumption	38 W Max when charging
Dimensions	130mm x 90mm x 38mm
Weight	650 g

## Belt Clip and ILD-2 Holster

Available as accessories converting the ILD-C and ILD-2 into a portable light source system for our rigid borescopes and fiberscopes.



## Long-life Halogen Light Source ILK-7C (Not Available in All Areas)

Refined for environmental resistance and long life, this model is suitable for use on production lines.



- **Significantly longer life**

The life of the light source has been dramatically extended to an average 500 hours when 15 V 150 W lamps are used.

- **Improved environmental resistance**

The circuit board is insulated with a silicon rubber coating that reduces the possibility of short-circuiting and improves atmospheric-resistance at the site.



### Specifications

	ILK-7C
Voltage*	100-120 V 50-60 Hz, 115 V 400 Hz
Power consumption	280 W
Dimensions	178 (W) X 76 (H) X 230 (D) mm
Weight	2.3 kg

\* When voltage in your country is NOT 100-120 V, a voltage transformer is required to provide optimal voltage that accommodates the specs. of the optical source device.

## Halogen Light Source ILK-7/ILK-7A/ILK-7B

The ILK-7 range of light sources incorporates a 150 W tungsten-halogen lamp offering features necessary to meet most industrial needs.



### Specifications

	ILK-7	ILK-7A	ILK-7B
Voltage	100-120 V 50-60 Hz, 115 V 400 Hz	100-240 V 50-60 Hz, 115 V 400 Hz, 11-15V DC	100-240 V 50-60 Hz, 115 V 400 Hz
Power consumption	280 W		250 W
Dimensions	178 (W) X 76 (H) X 230 (D) mm		
Weight	2.3 kg		

## Metal-halide High Intensity Light Source ILH-2A/ILH-2B

With three times the intensity of its predecessor, this high-output light source is ideal for observation inside large spaces.



### Specifications

	ILH-2A	ILH-2B
Voltage	100-240 V AC	10-15 V DC
Power consumption	100W	110W
Dimensions	173 (W) X 85 (H) X 235 (D) mm	
Weight	3.0 kg	

## UHP High Intensity Light Source ILP-2

Bright and compact—the ILP-2 light source has been specifically designed for large void inspections. Incorporating the latest UHP lamp technology it is now the brightest, most powerful light source ever produced by Olympus.



### Specifications

	ILP-2
Voltage	100-240 V AC, 10-15 V DC
Power consumption	100 W
Dimensions	166 (W) X 109 (H) X 261 (D) mm
Weight	2.9 kg

Not available for the Small diameter borescopes. In use with the other rigid borescopes, connectable light guides differ depending on the rigid borescope models. Please ask our sales representatives for details.

## Portable Halogen Light Source ILK-D1/ILK-D2

The compact, portable light sources are operated from 12 V DC supply. They can be mounted on a belt or jacket pocket using a spring clip.



### Specifications

	ILK-D1	ILK-D2
Voltage	12 V DC	
Power consumption	80 W	105 W
Dimensions	80 (W) X 60 (H) X 140 (D) mm	147 (W) X 75 (H) X 168 (D) mm
Weight	0.6 kg	

## UV Light Source

(Recommended Models are Available from our Sales Representatives)

Olympus offers high power UV light sources compatible with all the light guide cables and fiberscopes for fluorescent testing.

# Accessories

## For Industrial Videoscopes IPLEX series

### Rigid Sleeve

- MAJ-1737 (for  $\varnothing 4.0$  mm dia. insertion tube)
- MAJ-1281 (for  $\varnothing 4.4$  mm dia. insertion tube)
- MAJ-1253 (for  $\varnothing 6.0/\varnothing 6.2$  mm dia. insertion tube)

Useful as an auxiliary insertion tool and also makes the scope easier to handle. Simply fit and lock the sleeve onto the tip of the insertion tube.



### Retrieval Tools (for IPLEX FX)

Various retrieval tools are available depending on objects.



Snare MAJ-1353 Alligator MAJ-1354 Basket MAJ-1355 Grasper MAJ-1356 Magnet MAJ-1357

### Battery and Charger (for IPLEX FX / IPLEX YS)

- NP-L7S (Lithium-ion battery)
- JL-2PLUS/OL-0 (Charger, 115 V type)
- JL-2PLUS/OL-1 (Charger, 220 V type)

The battery provides over 2 hours of operating time.



### Battery and Charger

(for IPLEX RX / IPLEX RT / IPLEX LX / IPLEX LT / IPLEX TX / IPLEX MX II)

- NO2040NO29 (Lithium-ion battery)
- CH5000C (Charger, USA type)
- CH5000X (Charger, European type)

The battery provides 2 hours of operating time.

Note: Over 100-minute operating time for the IV88 series.



### Battery and Charger (for IPLEX UltraLite)

- IB-1 (Lithium-ion battery)
- IC-1 (Charger)

The battery provides approximately 90 minutes of operating time.



### Handheld Controller Holder (for IPLEX FX / IPLEX LX / IPLEX LT)

- MB-937

Allows the handheld controller to be affixed to a tripod, making it useful for prolonged inspections.



### LCD Monitor Extension Cable (for IPLEX FX)

- SU492400 Length: 2 m

The 2 m length cable allows you to operate the main unit while moving freely around a expanded area.

Note: The LCD monitor shown in this photo does not come with this cable.



### UV Inspection Adaptors\*1 (for IPLEX FX / IPLEX UltraLite)

Enable the UV inspections by being attached onto the IPLEX FX scope tip.

\*1 Built-to-order



Image with a general optical adaptor



Image with an UV inspection adaptor

### Tripod Adaptor (for IPLEX UltraLite)

- MAJ-2017

Makes it possible to mount the IPLEX UltraLite on a tripod for increased stability during prolonged inspections.



### Durable Carrying Case (for IPLEX UltraLite)

- MAJ-2019

This optional durable case fully protects the instrument from damage during shipment. It is small enough to fit in the overhead compartment of most aircraft, making it ideal for frequent transport.





## Guide Tube for Long Scope

(for IPLEX FX)

- MAJ-1824-50 (for IV8650)
- MAJ-1824-75 (for IV8675)
- MAJ-1824-120 (for IV86120)
- MAJ-1824-180 (for IV86180)

Protects the scope and assists in smooth entry when inserting it into a wide pipe.

Note: The guide tubes for the IPLEX RX and RT are also available as built-to-order products.



## Guide Tube with Articulation for Inspection of JT8D Engines\*1

(for IPLEX FX / IPLEX RX / IPLEX RT)

Provides a second movable joint for incredibly flexible control, which is ideal for inspecting the combustion chamber of JT8D engines.

Available on IV86 and IV96 series.

Note: Pratt & Whitney approved for JT8D engine inspection.



\*1 Built-to-order

## High Temperature Guide Tube\*1

- MAJ-1867 (for 4 mm insertion tube)

The High Temperature Guide Tube is able to operate at temperatures up to 250°C which makes it ideally suited for inspections of hot aircraft engines, boilers, and furnaces. The benefit of utilising this guide tube is that inspections can start at a higher temperature, thereby reducing the waiting time for the inspected area to cool down.

\*1 Built-to-order



## Centring Device Set (for 8.5mm insertion tube)

- MAJ-1935

Allows you to centre the scope inside a pipe by attaching it to the scope distal end. The set consists of two devices in 75 mm and 140 mm finger lengths.



## Protective Braid\*1 (for IPLEX TX)

Covers the IPLEX TX insertion tube providing additional protection when used in very coarse environments.

\*1 Built-to-order



## Flex and Stay\*2 (for IPLEX series)

Enables the videoscope and fiberscope to be housed in a semi-flexible tube supporting the scope insertion to difficult areas.

\*2 This adaptor can be used for the Industrial fiberscopes as well.



## Side View Rigid Sleeve (for IPLEX MX II)

- MAJ-1730 (for ø4.4 mm)
- MAJ-1731 (for ø6.0 mm)

Side view rigid sleeve with prism-style LED illumination enables effective inspection of small gas turbine engines.



## Length Indicator\*1 (for IPLEX YS)

Indicates how far the insertion tube is inserted into an object.

\*1 Built-to-order



## Pushing Rod\*1 (for IPLEX YS)

Provides support for inserting the scope tip into a deep area.

\*1 Built-to-order



## Remote Controller Extension Cable\*1

- MAJ-1091 (for IPLEX YS)

Extends the remote control cable by 4 m, permitting free movement during operation.

\*1 Built-to-order



## CO<sub>2</sub> Cartridge\*<sup>3</sup> (for IPLEX YS)

The portable CO<sub>2</sub> cartridge can be fixed onto the IPLEX YS, letting you manipulate scope articulation without a bulky compressor.

\*<sup>3</sup> Please consult a sales representative for the recommended model.



## Side View Mirror Adaptor\*<sup>6</sup> (for IPLEX MX II)

You can change the direction of view by mounting the side viewing tip adaptor. The diameter of the side viewing tip adaptor is  $\varnothing 7.4$  mm

\*<sup>6</sup> Exclusively for use on IV8630M.



# For Industrial Fiberscopes / Industrial Rigid Borescopes

## OM Adaptors\*<sup>4</sup>

Allow you to connect industrial fiberscopes or rigid borescopes to selected Olympus digital SLR cameras or mirrorless ones.

\*<sup>4</sup> The optional OM adaptor MF-1 or MF-2 is required to connect the OM adaptors listed below to the digital SLR cameras or mirrorless ones.



SM-R+MF-2

	AI-3M/AI-4M	AK-1M/SM-R
Compatible scope* <sup>5</sup>	IF4D5/4S5 IF5D4X1 IF6C5X1 IF8C5 IF11C5	IF6PD4 IF2D5 IF8D4X2/X3 K12/17/27, X09/12/17/25 Miniboscopes Series 5 Rigid Borescopes
Camera connector	MF-1 for connection to the digital SLR cameras. MF-2 for connection to the mirrorless cameras.	

Notes: Magnification of the AI-4M 1.3X larger than the AI-3M.  
Magnification of the AK-1M is 1.8X larger than the SM-R.

\*<sup>5</sup> Moire may appear if pixel interference occurs in certain inspection environments (such as fibre mesh and image sensor) or in certain output devices (such as LCDs and printers).

## C-mount Adaptors

For connection of TV cameras to Fiberscopes and Rigid Borescopes.



AI-3C

Scope	C-mount adaptor	Magnification ratio	Brightness ratio
IF3 Series IF7D3X3-26, 32 IF13D3-60, IF8D3X2-23 Image Carriers	MC-04	0.8	1.6
	MC-05	1.0	1.0
IF4D4/4S4, IF5D4X1 IF6D4, IF8D4, IF11D4 IF4D5/4S5, IF6C5, IF6C5X1 IF8C5, IF11C5	AI-10C	0.8	1.56
	AI-11C	1.0	1.0
	AI-12C	1.51	0.44
	AI-3C	2.0	0.25
IF6PD4, IF2D4, IF2D5 Rigid Borescopes Miniboscopes Modelscope	AK2-5C	0.75	1.8
	AK2-10C	1.0	1.0
	AK2-20C	1.35	0.55
	MC-R44	1.85	0.3
	MC-R58	2.4	0.17

## Light Guide Cable

This accessory transmits light from a separate light source.



## Multi-purpose Sleeve

Useful to provide a constant insertion depth of rigid Borescopes.



# Inspection Magnification Charts

## Magnification Ratio of IPLEX-series Monitors

Note: The magnification chart of the IPLEX MX II in 6.0 mm dia. is approximately same as that of AT120D/FF-IV84.

### Far focus adaptor

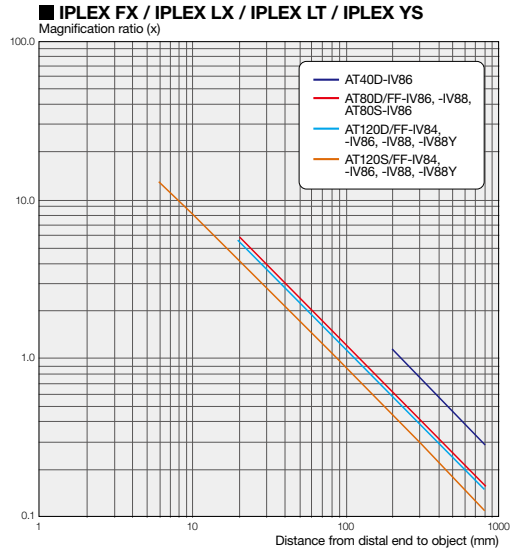

### Near focus adaptor

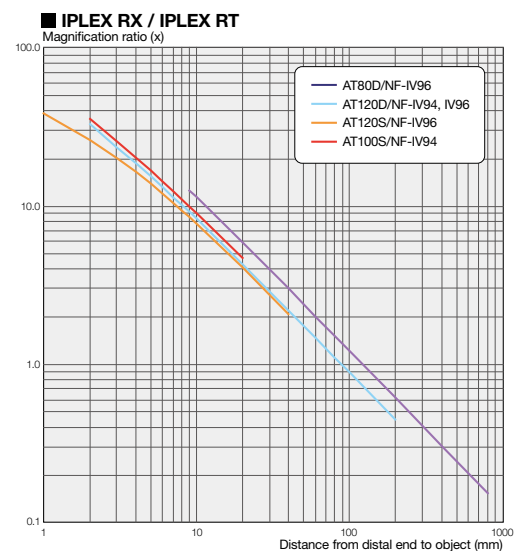
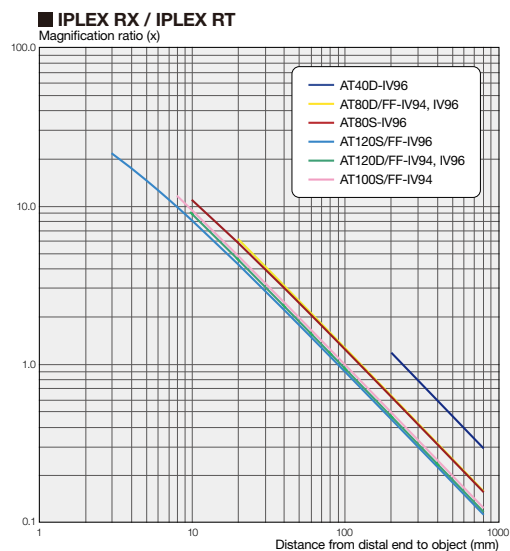
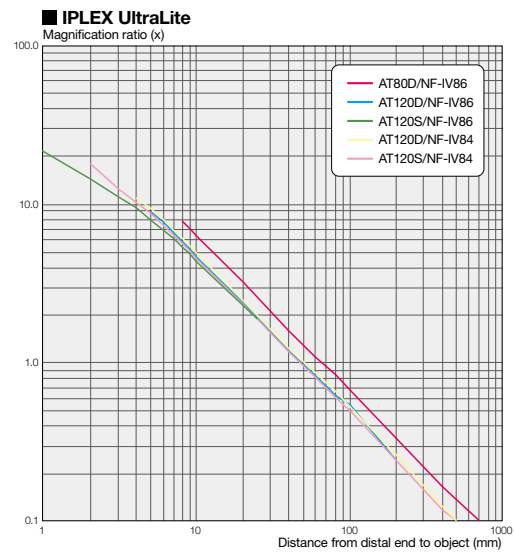
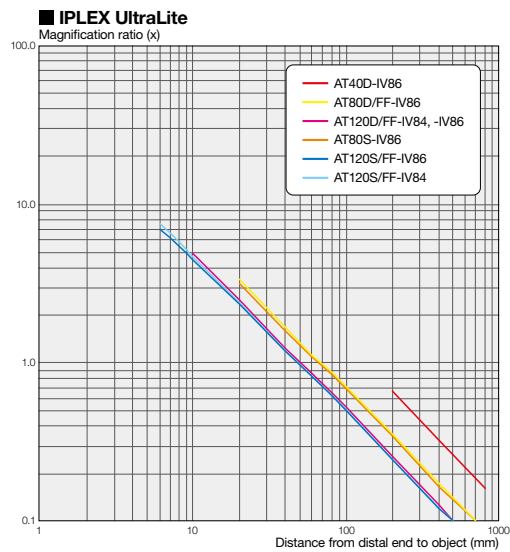
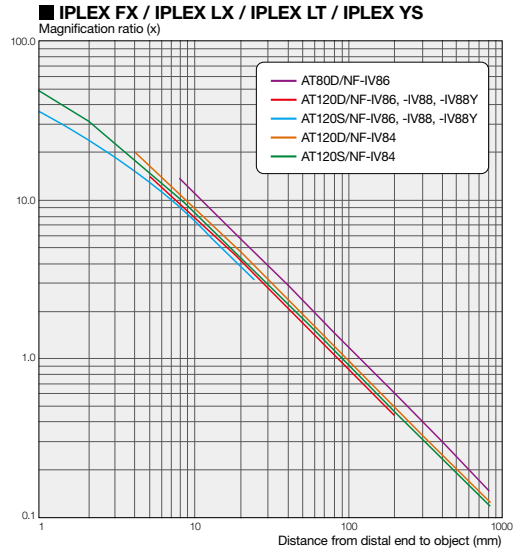



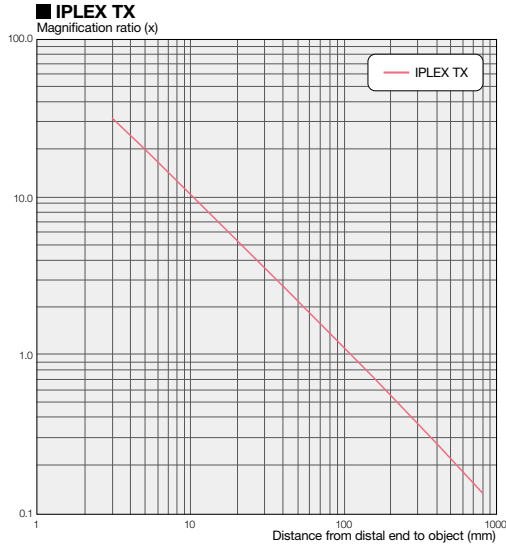

## Range of Magnification Ratios During Inspection

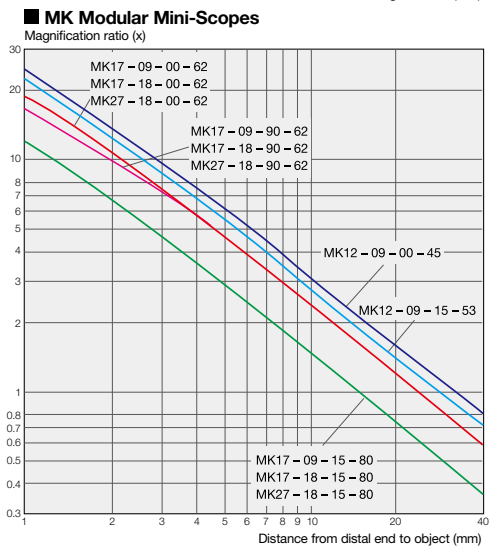
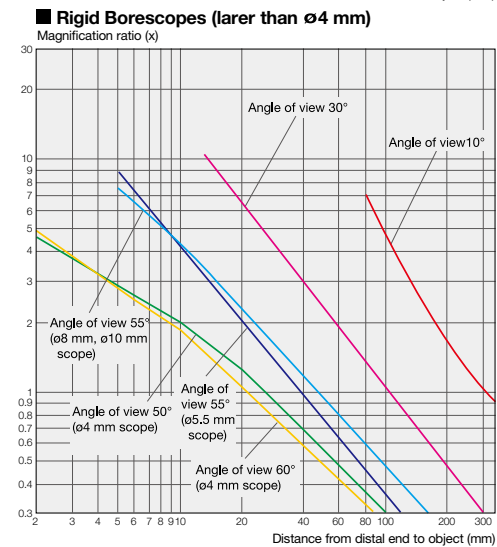
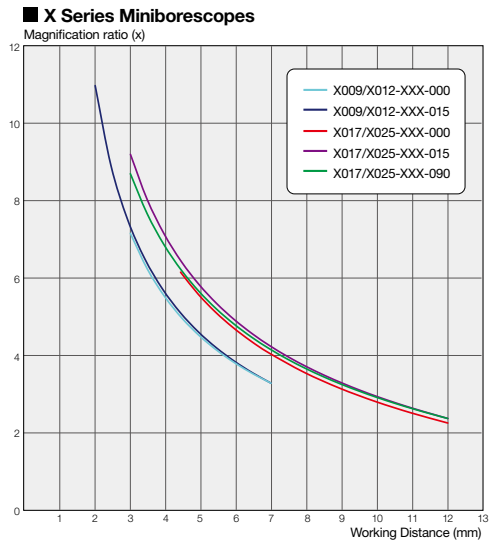
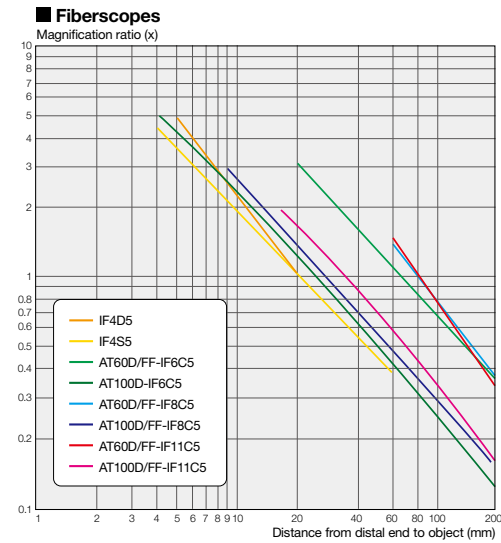

# System Charts

## Videoscopes

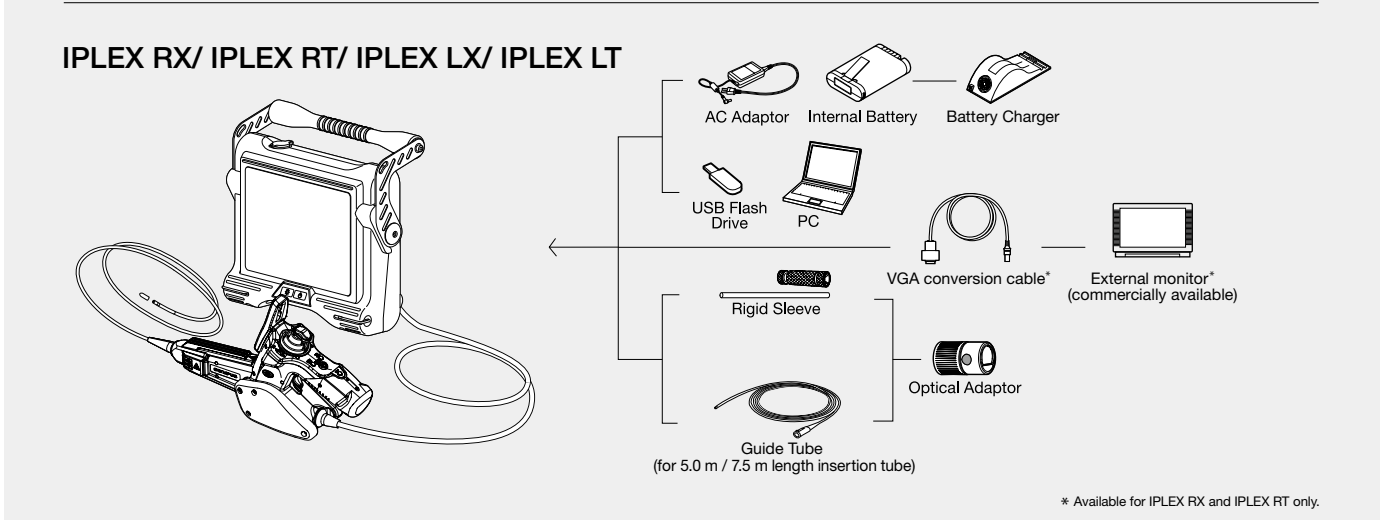
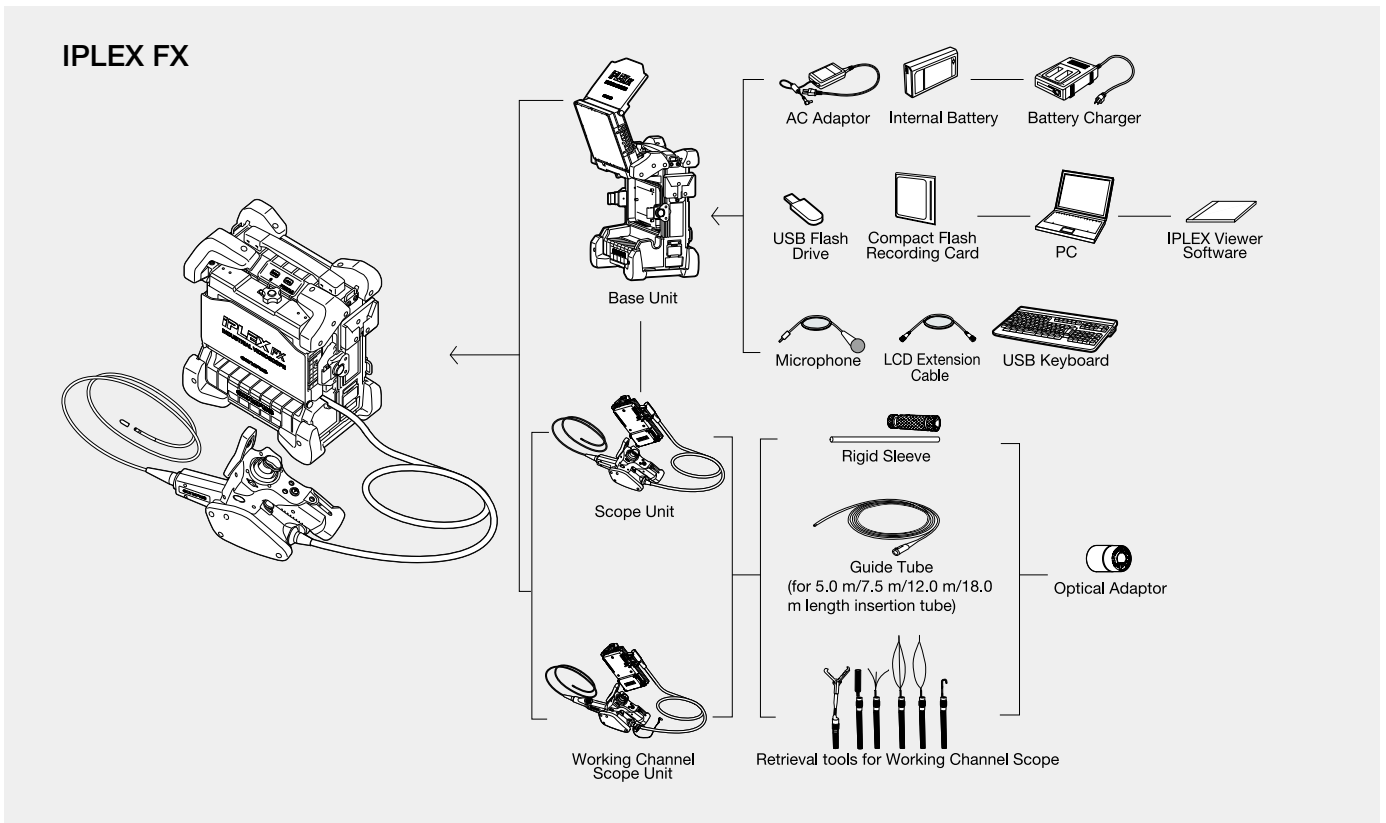

\* Available for IPLEX RX and IPLEX RT only.

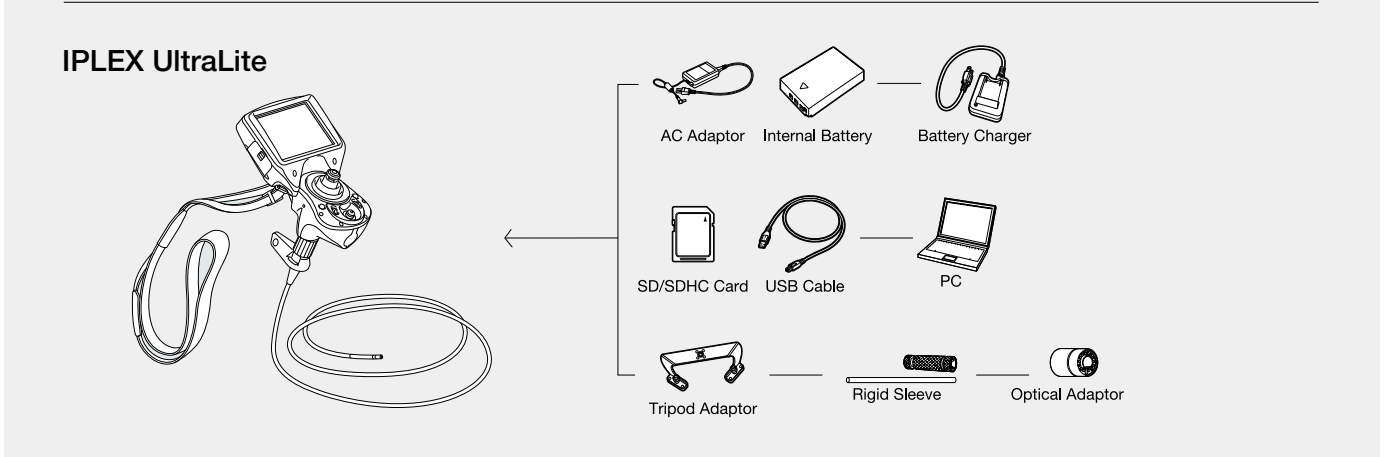

## IPLEX TX

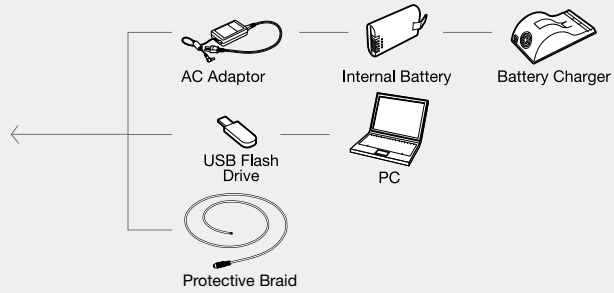
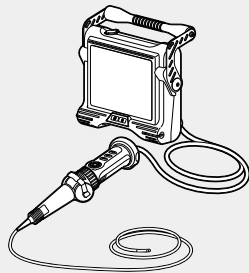

## IPLEX YS

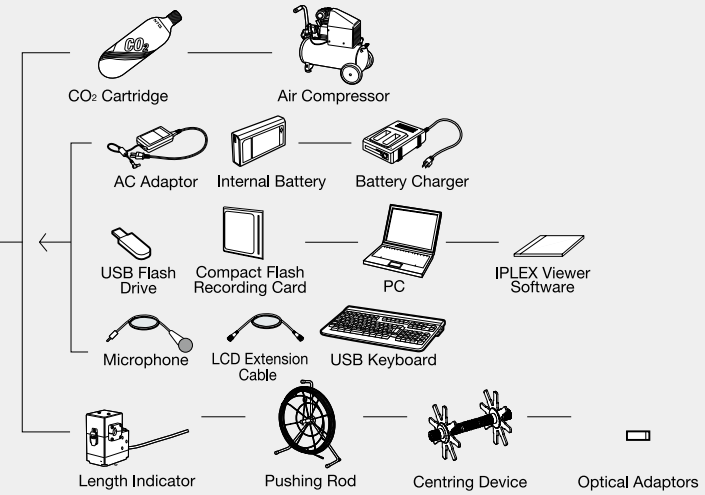
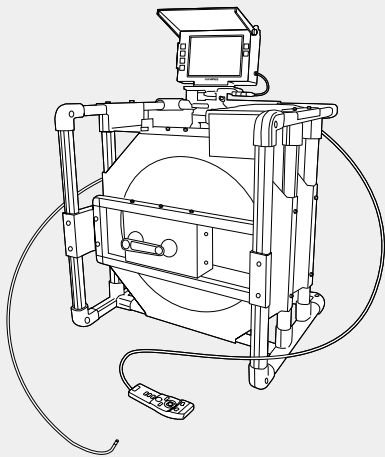

## IPLEX MX II

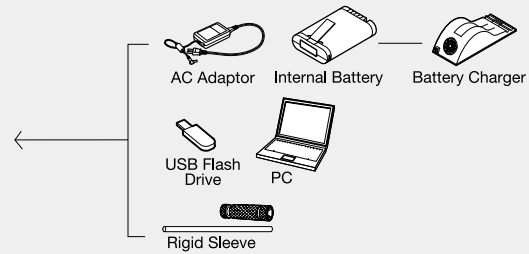
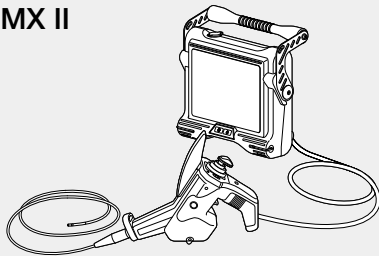

## Fiberscopes and Rigid Borescopes

### Eyeball Observation System

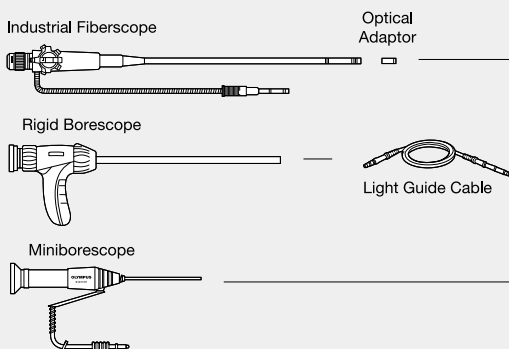

### TV Observation System

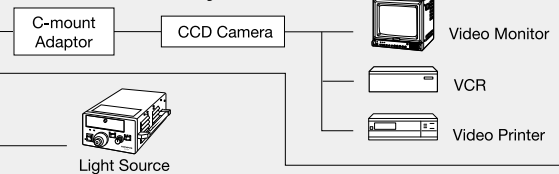

### Photograph System





The IPLEX YS industrial videoscope is equipped with the laser illumination.

- OLYMPUS CORPORATION is ISO9001/ISO14001 certified.
  - This product is designed for use in industrial environments for the EMC performance. Using it in a residential environment may affect other equipment in the environment.
  - Specifications, design and accessories are subject to change without any notice or obligation on the part of the manufacturer.
  - All brands are trademarks or registered trademarks of their respective owners.
- Copyright © 2013 by Olympus

[www.olympus-ims.com](http://www.olympus-ims.com)

**OLYMPUS**<sup>®</sup>

For enquiries-contact  
[www.olympus-ims.com/contact-us](http://www.olympus-ims.com/contact-us)

**OLYMPUS CORPORATION**

Shinjuku Monolith, 3-1 Nishi-Shinjuku 2-chome, Shinjuku-ku, Tokyo 163-0914, Japan Tel: +81 (0) 3-6901-4038

**OLYMPUS SCIENTIFIC SOLUTIONS AMERICAS CORP.**

48 Woerd Avenue, Waltham, MA 02453, USA, Tel.: (1) 781-419-3900  
12569 Gulf Freeway, Houston, TX 77034, USA, Tel.: (1) 281-922-9300

**OLYMPUS NDT CANADA INC.**

505, boul. du Parc-Technologique, Québec (Québec) G1P 4S9, Tel.: (1) 418-872-1155  
1109 78 Ave, Edmonton (Alberta) T6P 1L8

**OLYMPUS INDUSTRIAL SYSTEMS EUROPA**

Stock Road, Southend on Sea, Essex, SS2 5QH, United Kingdom  
Tel: 44 (0)1702 616333 E-mail: [industrial@olympus.co.uk](mailto:industrial@olympus.co.uk)

**OLYMPUS SINGAPORE PTE LTD.**

481B River Valley Road, #12-01/04 Valley Point Office Tower, 248373, Singapore Tel: +65 68-34-00-10

**OLYMPUS AUSTRALIA PTY LTD.**

3 Acacia Place, Notting Hill VIC 3168, Australia  
Tel: +61 130-013-2992